

RAKOSO

H400

User's Manual

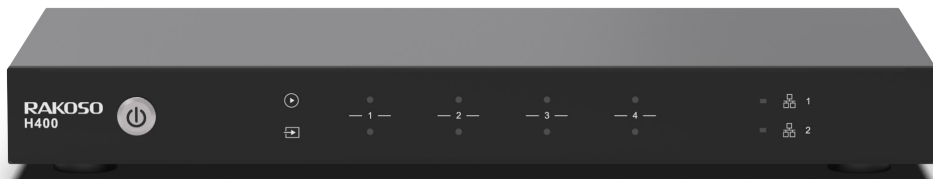

Network 4 Zone Pre-Amplifier

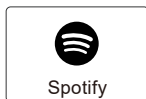
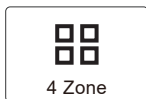

Table of contents

1. Introduction	1
2. System Requirements	1
3. What's in the box	2
3.1 Front Panel	3
3.2 Back Panel	3
4. Remote controller	4
5. Connection diagram	5
5.1 How to use	6
5.2 App download	6
5.3 Connection	7
5.4 Connect to USB storage device	7
5.5 Connect to audio playback device	8
5.6 RS232 Serial Port	8
5.7 Connect to network	9
6. Download 4Stream APP	10
7. Using H400	10
7.1 Selecting a zone	10
7.2 Play same music to multiple rooms	11
7.3 Listen to online music	12
7.4 Spotify	12
7.5 Airplay	12
7.6 Qplay	12
7.7 Listen to local music	12
7.8 Music Playlist	13
7.9 Play music from line in	13
7.10 Play music from Optical/Coaxial in	13
7.11 Play music from PC	13
7.12 Changing Output channels	13
8. Device Settings	14
9. Firmware Update	14
10. Specification	15
11. FAQ	16

1. Introduction

H400 is a multi-room system that enables you to enjoy your favorite music anywhere in your home. H400 contains 4 audio streamers for you to use as audio source, you can easily play music from online music services, your phone storage, NAS and other sources by using the 4Stream app on your iOS or Android device.

- *Multi-room audio function: play different songs in different rooms or same song in every room.*

- *Easy network setup: Connect to your home network and it is ready to use.*

- *Rich I/O interface: Each zone has separate digital output and analog input/output. There is also a master source input that all zones can be used at the same time.*

2. System Requirements

High Speed Internet Connection:

H400 needs internet connection to stream music from online music services and to get online firmware updates. You may experience performance issues with slower internet connections.

Wireless Router:

In order to use H400, you will need to have a working Wi-Fi network in your home, since the control APP on your mobile device need to be in the same network as the streamer.

Control APP – 4Stream:

You can control H400 using our free 4Stream app on any iOS and Android device that meets these minimum requirements:



3. What's in the box

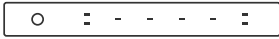

H400

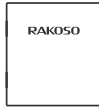

User's Manual

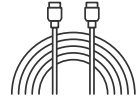

Ethernet Cable

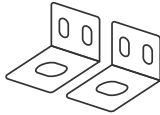

Rack Mount Brackets x2

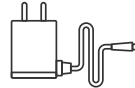

12V/2A Power Adapter

3.1 Font Panel

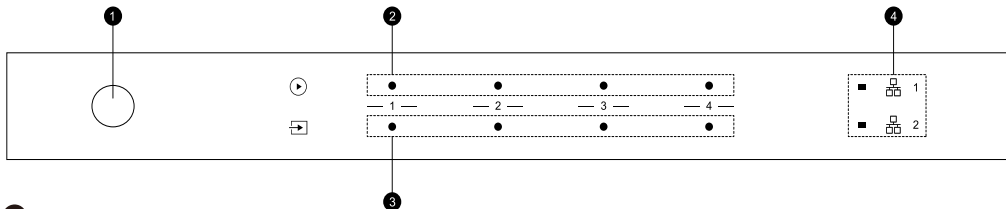

- 1 Power Button
- 2 Streaming Indicator – LED on when streaming.
- 3 Input Source Indicator – LED Color: White for Network Audio, Green for Line in 1 (Zone Line in), Yellow for Line in 2 (Master Line in), Magenta for Master Optical in, Cyan for Master Coaxial in, Red for USB.
- 4 Network Indicators – LED on when network is available.

3.2 Back Panel

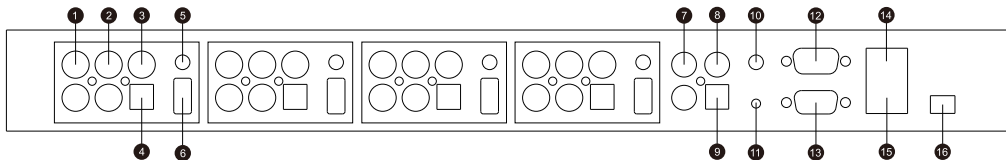

- 1 Pre-Out
- 2 Line In (Line 1 in APP)
- 3 Digital Coaxial Out
- 5 Digital Optical Out
- 4 12V Trigger out
- 6 USB port
- 7 Master Line In (Line in 2 in APP)
- 8 Master Digital Coaxial In
- 9 Master Digital Optical In
- 10 Master 12V Trigger out
- 11 Reset button
- 12 Pass Through (RS232 port)
- 13 RS232 Port
- 14 Network input
- 15 Network output
- 16 DC input

4. Placing your H400

H400 is an audio streamer and need to use with an external device that offers audio amplification. You should place H400 near to the amplification device you want to connect to.

H400 is designed to fit in a 1U equipment rack for easy installation. Attach the included rack mounting brackets on each side of H400 if you want to mount it in a standard EIA equipment rack.

- Remove the two screws on each side of H400

- Align the rack mounting brackets with the screw holes and screw back the screws, make sure they are tightly secure.

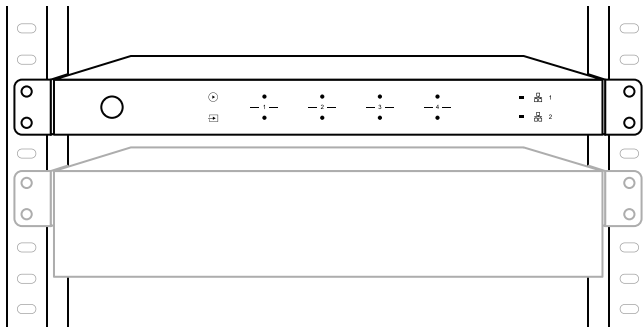

5. Zone Connection

You can play the same audio source in all four zone at the same time, you can also play different audio sources in different zones.

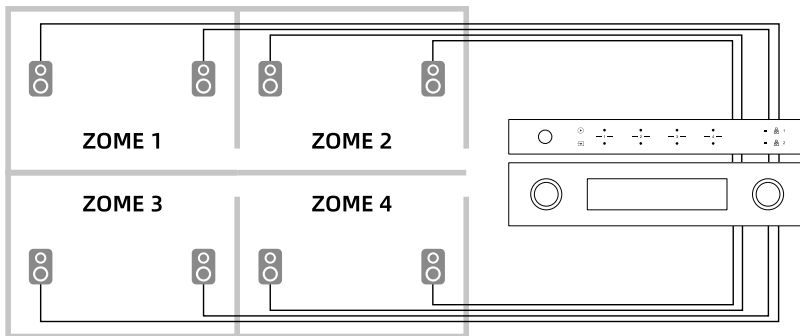
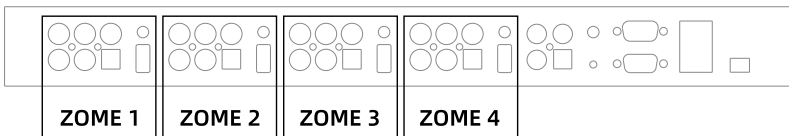

5.1 Connect to external amplifier or AV receiver

Connect the LINE OUT output to the input on your amplifier or AV receiver using the appropriate cable. H400 supports both analog output (RCA) and digital output (Optical & Coaxial).

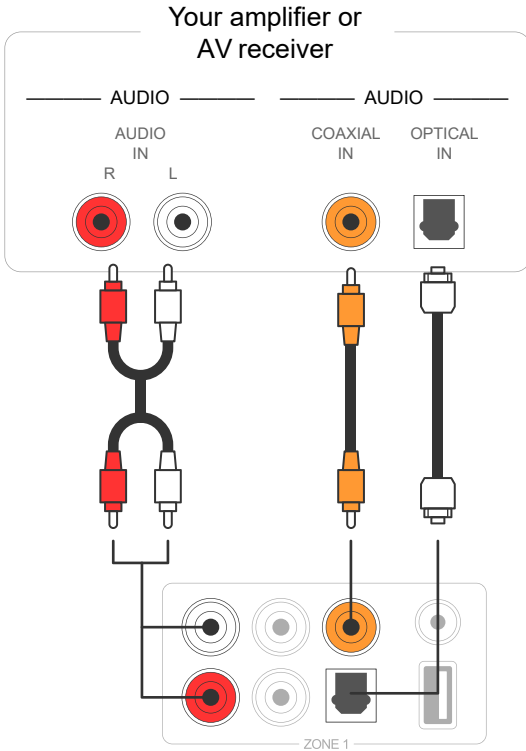

5.2 Connect to external subwoofer

Connect the LINE OUT " L " output to the input on your active subwoofer or subwoofer amplifier.

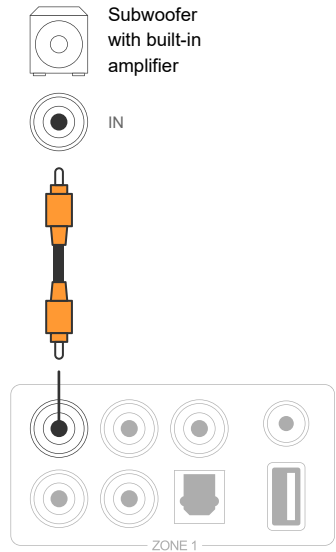

5.3 Trigger Control

If the audio amplifier connected to H400 has a trigger input connector, you can connect it to the TRIGGER OUT of H400 using a 4.5mm cable (not included). A 12V/150mA signal is output from the TRIGGER OUT port.

Use a monaural mini-plug cable for connecting the TRIGGER OUT port. Do not use a stereo mini-plug cable.

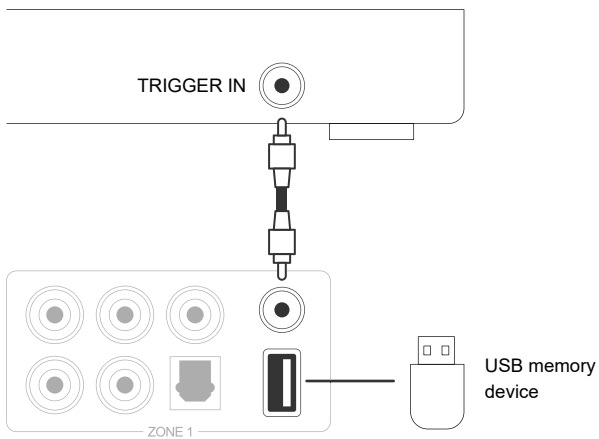

5.4 Connect to USB storage device

To play music stored in a USB storage device, just plugin a USB storage device containing music files to the USB port of the Zone you want to play with.

5.5 Connect to audio playback device

Connect the LINE IN in each zone or LINE IN, COAXIAL IN, OPTICAL IN in the master input area to an audio playback device, it can be a CD player, portable music player or any device with audio output using the same connector.

In the APP, LINE IN in each zone is represent as Line in 1, LINE IN in the master input area is represent as Line in 2.

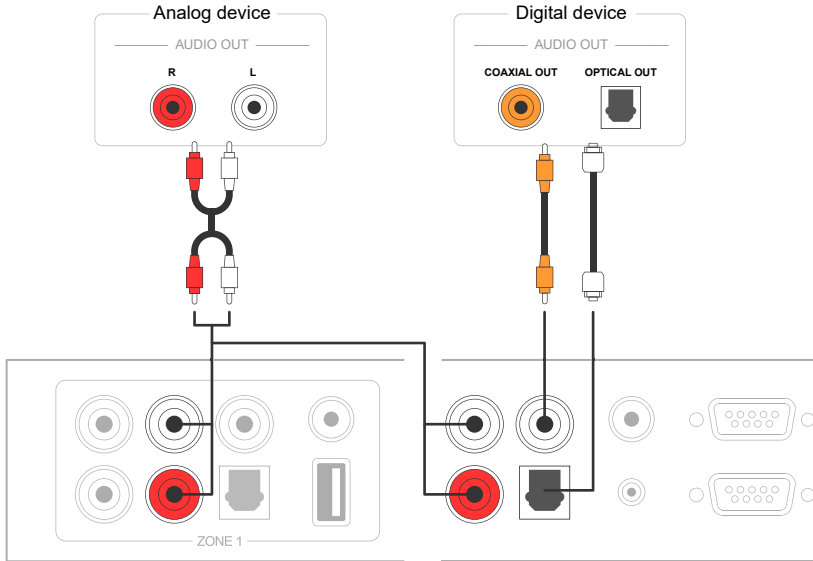

5.6 RS232 Serial Port

RS232 serial port is reserved for connection to smart home control unit to control H400. You can use the Pass-Through port to connect to another H400 for group control.

5.7 Connect to network

Connect H400 to your home router using a LAN cable to add it into your home network. You can use the NETWORK OUT port to connect another device to the same network.

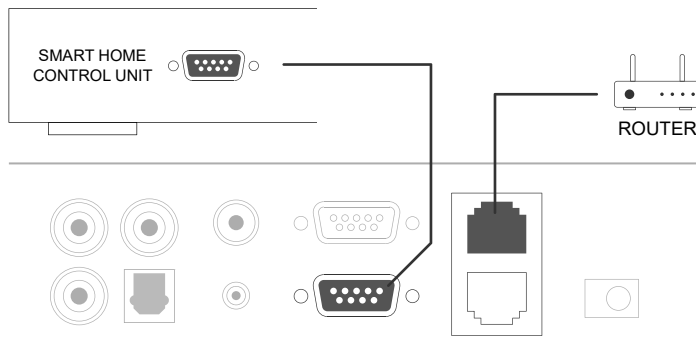

6. Download 4Stream APP

The 4Stream APP is the controller of the whole system. Install 4Stream APP in your mobile device and you can control and stream music anywhere in your home.

The application supports English, Spanish, French, German, Italian, Portuguese, Korean, Simplified Chinese, Traditional Chinese and Japanese.

You can download 4Stream App for iOS or Android by searching "4Stream" in App Store or Google Play.



7. Using H400

Once you have connected your H400 to your network and install 4Stream app in your mobile device, you can start playing music to different rooms. You can listen to different music in different room or the same music in all rooms in sync.

7.1 Selecting a zone

In 4Stream APP you will see all the connected devices in the same network.

1. Select the device you want to control, the selected device will have a green bar appears on the left side.
2. Swap to the left to open the list of music sources.
3. Select an online or local music source from the list to start streaming your music.

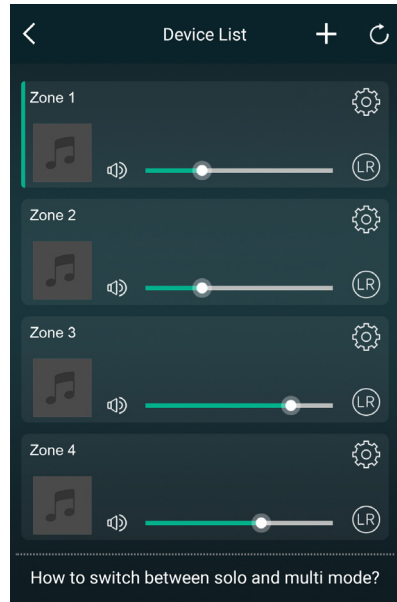

7.2 Play Same Music to Multiple Rooms

You can play the same music to multiple rooms simultaneously by adding other devices to form a group by pressing the “” icon beside the device. This device will be the master device, the music stream to the master device will also playback on other devices in the same group.

If you want to stream to multiple devices using Airplay2, you can just add the zones you want when you select device in airplay2 interface. If your music source is from Airplay2, this is the only method you can stream the same music to multiple devices.

If your music source is from the master source input, there is no need to group the devices, since all the devices can access the master source input.

*There will be a small delay between the audio source and the 4 zones when in multizone mode, all 4 zones will be in sync with no delay between them.

*There is no delay when you use the master source input as input source for the 4 zones. No need to group them together, ungroup them to play in sync with the input source.

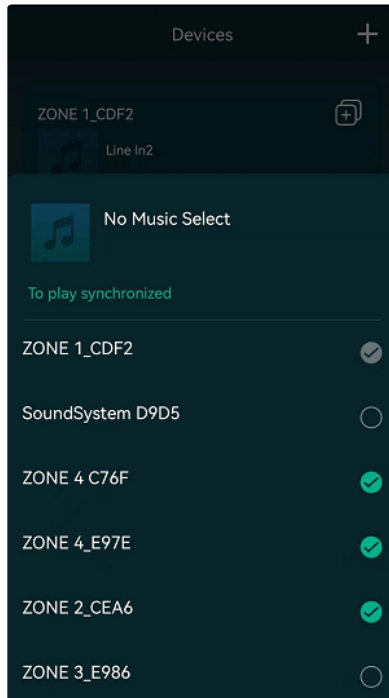

7.3 Listen to online music

H400 can work with famous online streaming music services like Spotify, Tidal, Qobuz, Deezer, Amazon Music, QQ Music, Tuneln, Internet radio, iHeartradio. You can easily stream music or playlist from your account wirelessly and play on your home audio system.

7.4 Spotify

To use Spotify, you need to have Spotify premium account. You will find the device in device list in Spotify application and choose the device you want to stream.

7.5 Airplay2

The device supports Airplay2, you can choose Airplay in iOS device and play music.

7.6 Qplay

The device supports QQ music using Qplay protocol, you need to turn on Qplay in QQ music application setting and then find the device in Qplay list

7.7 Listen to local music

H400 can stream local music stored in your mobile phone, USB storage drive, NAS using DLNA protocol, PC software like itunes, or UPnP/DLNA 3rd party software.

Click on "My Music" to select the local device you want to play from.

Note: iOS based devices have blocked the access to iTunes library.

*Our system only supports NAS using DLNA protocol.

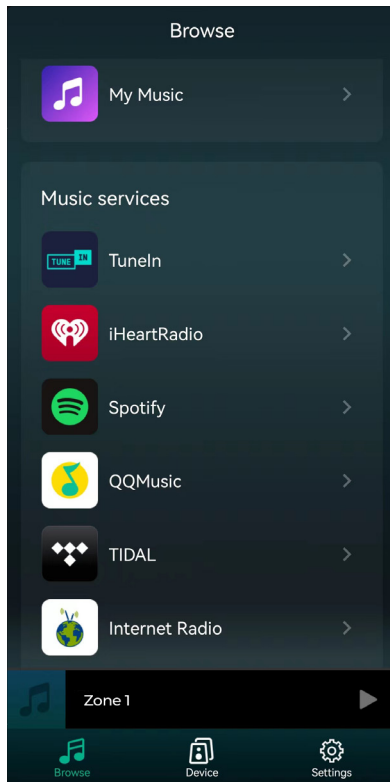

7.8 Music Playlist

You can create music playlist and add local music to the list for streaming.

7.9 Play music from line in

Connect an external audio source to line-in port using RCA cable.

Choose line in mode in the 4Stream application to switch to line in mode.

-Line in 1 is the line in port of the current zone, Line in 2 is the line in port Of the master input source.

7.10 Play music from Optical/Coaxial in

Connect an external audio source to Optical/Coaxial in of the master input source.

Choose Optical or Coaxial in the 4Stream application to switch to the corresponding mode.

7.11 Play music from PC

You can stream audio stored in your Mac and Windows PC by using iTunes, 3rd party UPnP/DLNA streaming program like Foobar2000, Music Bee or Serviio.

7.12 Changing Output Channels

You can change the output channel of the zone, you can change between Left channel only, Right channel only or Stereo. You can set Zone 1 to play Left channel and Zone 2 to play right channel, group them together to make stereo. By default it is set to Stereo.

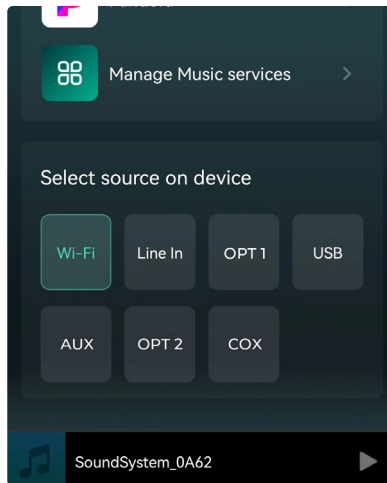
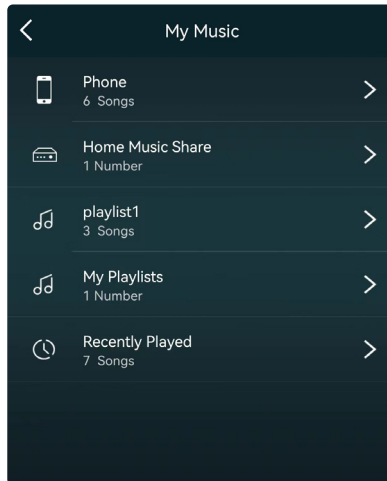

8. Device Settings

Rename: You can rename each zone to different name to fit your needs.

Speaker info: You will see the device information like device's IP address, Device name, Firmware Version and Restore Factory Default.

Preset: You can store 10 different playlist or radio station to the Preset list for quick access. Any list or station with the speaker icon can be preset. Click on the speaker icon and you can assign it to the preset list.

Restore Factory Settings: Long press the Reset button for 8 sec to restore the device to factory default settings. This will reset all the zone names, volume and current input source.

Alarm Clock: Setup music alarm clock, music can choose from Preset list, internet radio, iHeartRadio, Napster, Tidal, Spotify, Deezer and NAS

Sleep Timer: Setup a Countdown timer to stop music.

EQ: You can control treble and bass of the device.

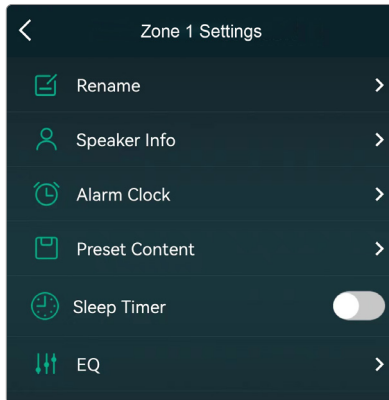

9. Firmware Update

Whenever a new firmware is available, you will be notified by a "new" icon. Click on the "new" icon to begin firmware update, it will take couple minutes.

It is recommended to update firmware when it is available, it might not only correct bugs or improve performance, but also might add new features or services.

10. Specification

4 Zone Audio I/O		
Audio Input	Line in	Max 2V RMS input
	USB	USB Playback
Audio Output	Line out	Max 2V RMS output
	SPDIF Optical	44.1KHz/16Bit output, multiroom function
	SPDIF Coaxial	
Master Input Source		
Audio Input	Line in	Max 2V RMS input
	SPDIF Optical	Max 192KHz/24Bit Sample Rate Decode PCM encoding
	SPDIF Coaxial	
Network		
Ethernet In	RJ45	
Ethernet Out	RJ45	Output to other device to share the network
General		
Power	12V DC in (12V/2A)	
	12V Master Trigger Output, Trigger Output on each zone	
Control Interface	Dual-way RS232	
Size	43x20x4.5(5.3 with footer) cm	

FAQ

Q: Do your devices support airplay and third-party DLNA apps?

A: Yes. They support airplay and third-party apps like MusicBee, Fooobar2000.

Q: How many zones can you group in one system?

A: 12 rooms is the maximum, while 8 zones are recommended.

Q: What distance can your wireless audio system cover?

A: Once the system is connected to your WiFi router, you can stream your music anywhere there is a WiFi signal.

Q: Can it play high resolution music?

A: Yes. Our devices can play APE and FLAC within the normal bit rate range. They also support decoding 24bit/192kHz music files.

Q: How many languages do you support?

A: Our devices will auto-detect your mobile device language and change automatically. Currently, we support English, French, German, Spanish, Chinese, Portuguese, Korean and Japanese and more on the way.

Q: What online music services do you support?

A: Spotify, Deezer, Tidal, Qobuz, Amazon Music, Napster, TuneIn radio, internet radio, iHeartRadio.

Q: Can I play local music?

A: Yes. You can play music from "MY MUSIC" on the application from local storage devices such as mobile device storage, USB thumb drives and NAS.

Q: Can the device work with Windows devices?

A: The Windows application is not available at the moment, but on the Windows PC, users can use iTunes, Fooobar2000 and Spotify connect.

Q: Can all music sources play in multiroom mode?

A: Yes, the online music services, digital and analog input all can stream in multiroom mode.



@Copyright 2023 by RAKOSO. All Rights Reserved.

The information contained in this guide is believed to be accurate and reliable. RAKOSO assumes no responsibility for any errors contained in this guide. RAKOSO reserves the rights to make changes in the specifications and/or design of the above mentioned product without prior notice. The diagrams contained in this guide may also not fully represent the product that you are using and they are for illustration purposes. RAKOSO assumes no responsibility for any differences between the product mentioned in this guide and the product you may have.