

# **ECP-T03**

## **Touch Panel**

### **【 User Manual 】**



**Lite-Puter Enterprise Co., Ltd.**

Website: [www.liteputer.com.tw](http://www.liteputer.com.tw)

E-mail: [sales@liteputer.com.tw](mailto:sales@liteputer.com.tw)

## INDEX

<b>PART 1 ECP-T03 INTRODUCTION .....</b>	<b>2</b>
CHAPTER 1 ECP-T03.....	2
1-1 FEATURE .....	2
1-2 SPECIFICATION.....	2
1-3 PORT INTRODUCTION.....	3
1-4 DIMENSION.....	3
1-5 SYSTEM DIAGRAM.....	6
<b>PART 2 ECP-T03'S PROGRAMMING SOFTWARE INTRODUCTION .....</b>	<b>7</b>
CHAPTER 1 FEATURE AND INSTALLATION .....	7
1-1 FEATURE .....	7
1-2 PROGRAMMING SOFTWARE AND DRIVER INSTALLATION .....	8
1-3 DEVICE DRIVER INSTALLATION .....	13
CHAPTER 2 · PROGRAMMING SOFTWARE INTRODUCTION .....	17
2-1 CONNECTION BETWEEN DEVICE AND PROGRAMMING SOFTWARE .....	17
2-2 MENU AND INTERFACE INTRODUCTION.....	18
2-3 COMPONENT (BUTTON, LABEL, BAR, CLOCK, PICTURE) OPERATION.....	23
2-4 PAGE OPERATION .....	43
2-5 BUTTON'S ADVANCED SETTING .....	49
2-6 SCENE OPERATION .....	54
2-7 SCHEDULE SETTING.....	57
2-8 COMPONENT CONFIGURATION.....	61
2-9 FILE DOWNLOAD .....	64
<b>GUARANTEE .....</b>	<b>68</b>

## Part 1 ECP-T03 Introduction

### Chapter 1 ECP-T03

#### 1-1 Feature

- Programming software to realize customized operation interface.
- USB port for LAN connection, data download and remote monitoring.
- Build-in function include backlight setting, sound setting, clock setting, digital photo frame and password protection.
- Build-in loudspeaker.
- Accept IR remote controller control.

#### 1-2 Specification

Power supply	DC: 12V
Signal input	RS-485 (EDX)
EDX terminal	4 PIN green terminal
Connection port	USB/LAN
RAM memory	256MB
Screen size	5.7 inch
Resolution	320*240PX
Color	262K colors
screen	4-wire resistive touch panel
Size	215(W)x140(H)x 39(D)cm

### 1-3 Port Introduction

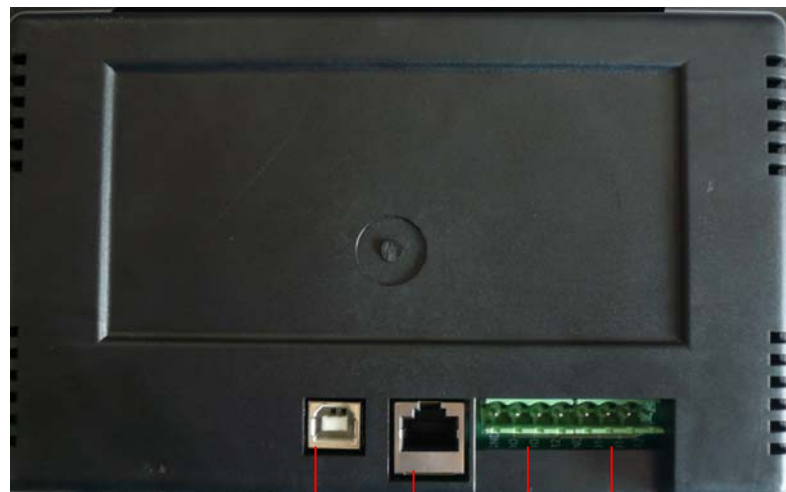

1	USB port	3	EDX port
2	LAN port	4	Spare port

### 1-4 Dimension

#### Back side

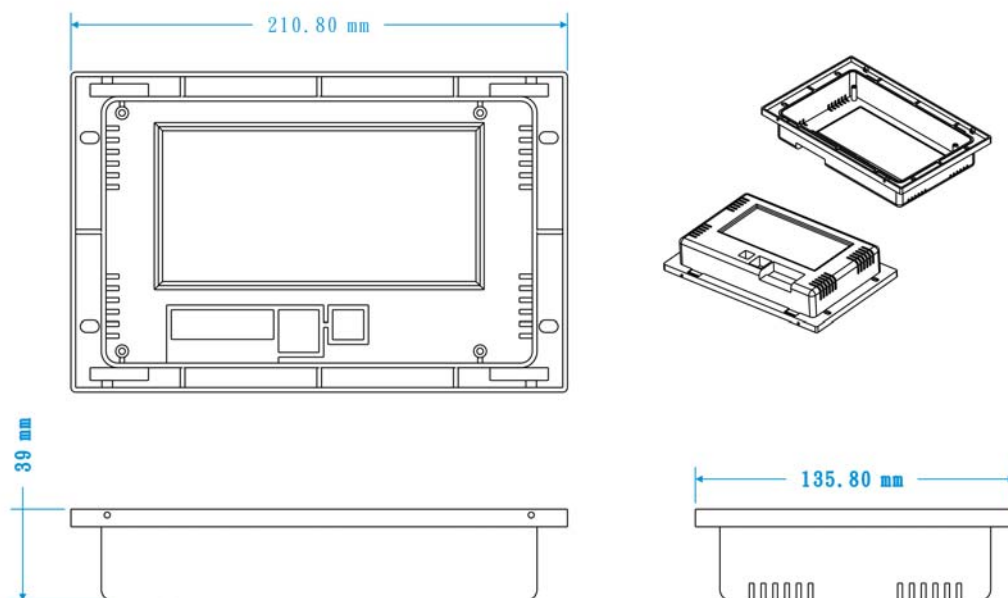

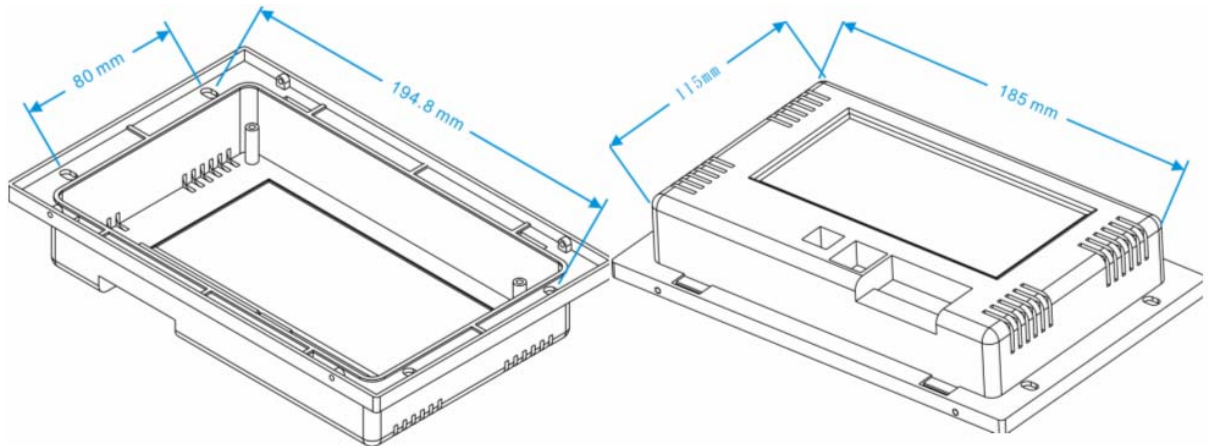

**Front side**

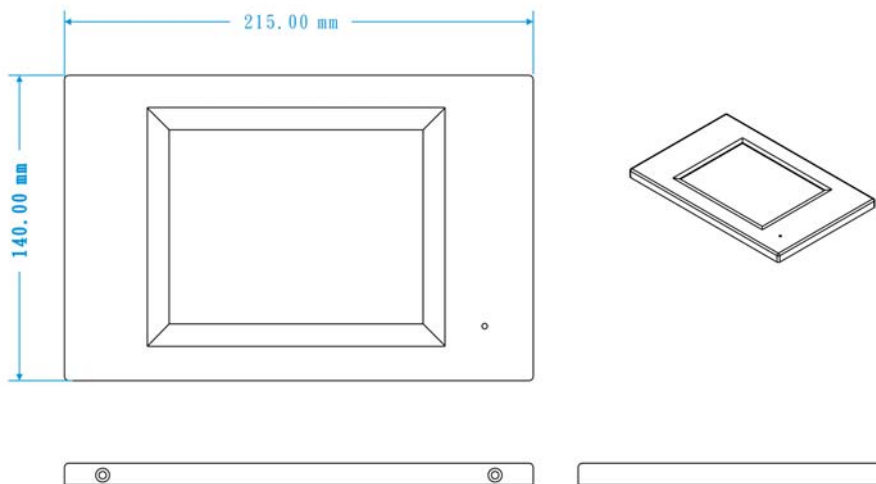

## Wall box

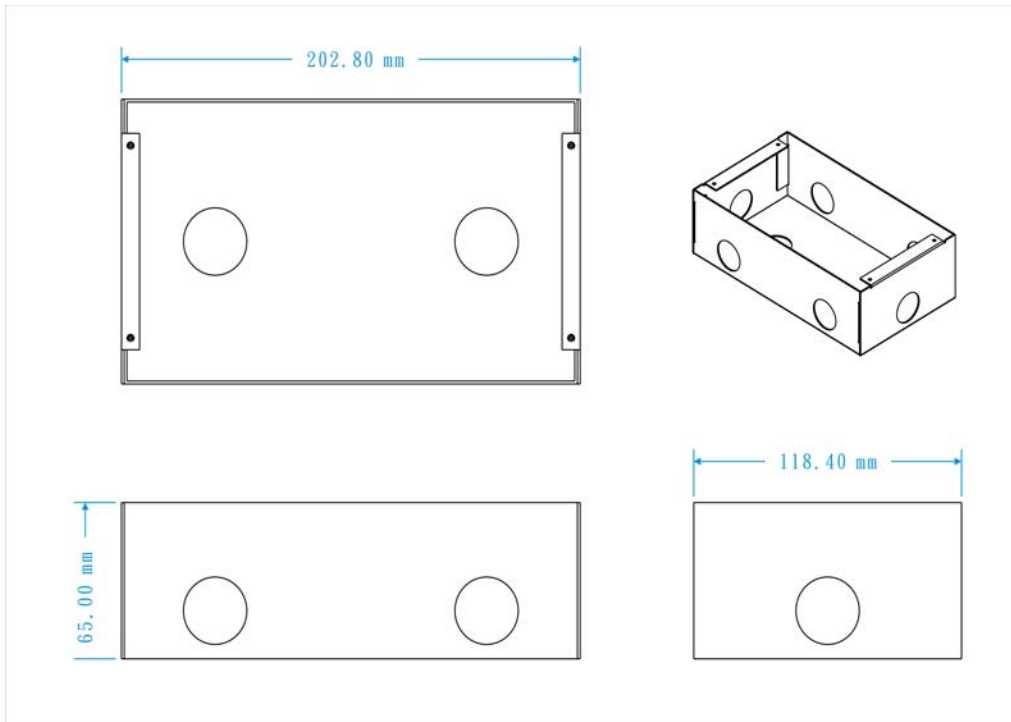

### 1-5 System Diagram

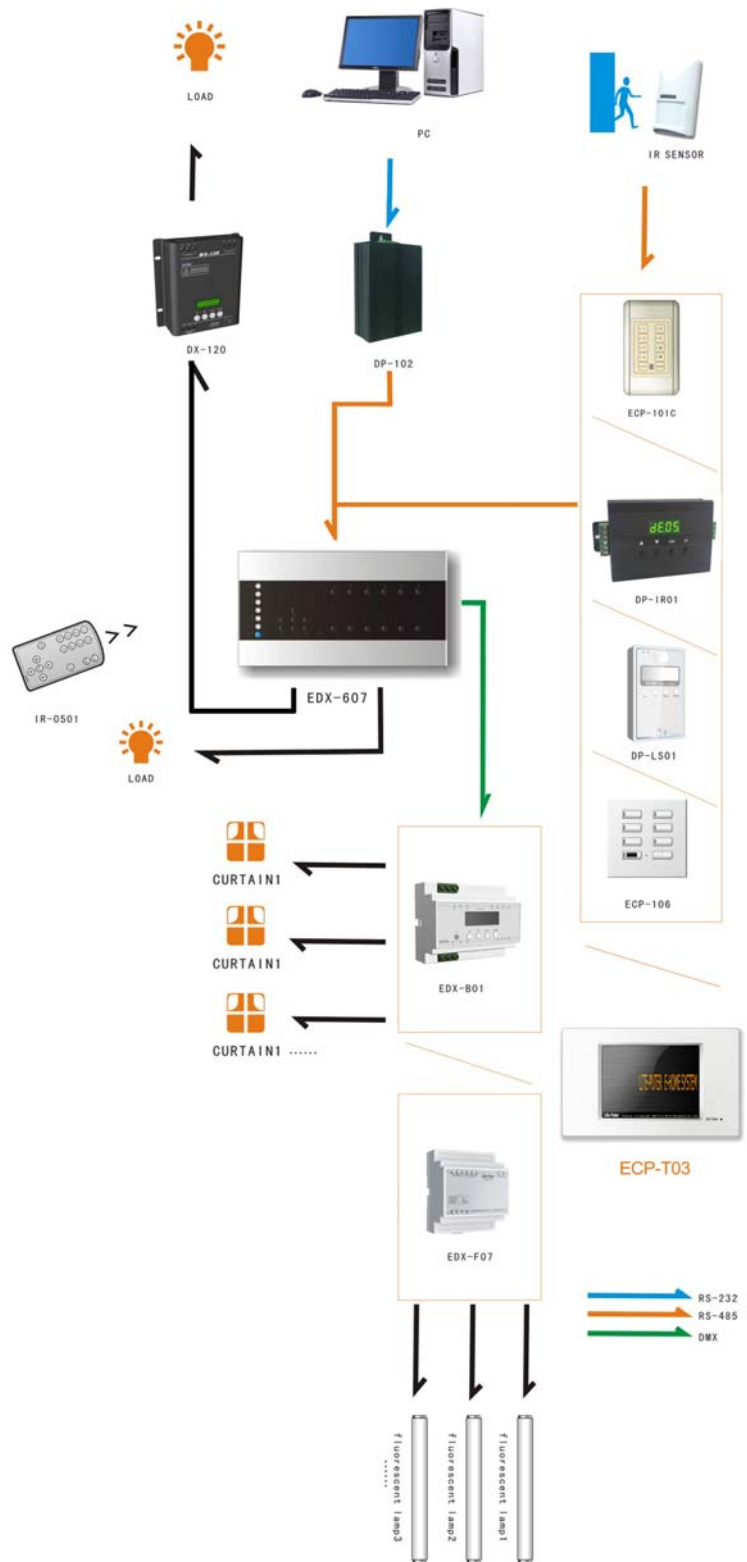

## Part 2 ECP-T03's Programming Software

### Introduction



## Chapter 1 Feature and Installation

### 1-1 Feature

-Page

- Has 1024 pages.
- The components include button, label, bar, clock, picture. User can configure them by the software.
- Download the page configuration to ECP-T03 by USB /LAN.
- Button component has background, text, shape and style options.
- Label and value component have text option.



-Timer

- Has 50 timer.

-Bulid-in function

- Clock set(can download from PC)

- Backlight set.(3 options: normal, turn off in 5mins and turn off in 20 mins)

- Voice set. (turn on/off screen tap sound)

- Schedule set/Preview function.

- Password protection.

The above function can be link to the buttons of the component.

## 1-2 Programming Software and Driver Installation

### 1-2-1 Programming Software Installation

STEP-1 Copy ECP-T03's install program from the CD to desktop as below,

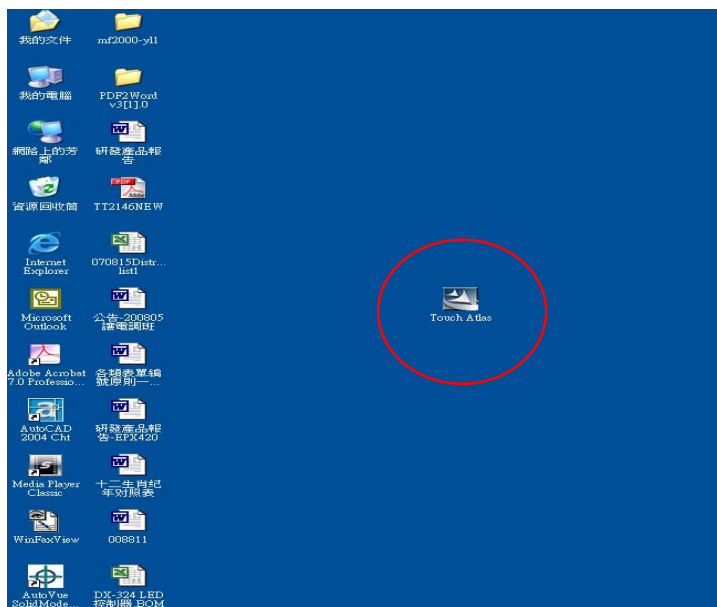

STEP-2 Double click the icon and it will display as below,

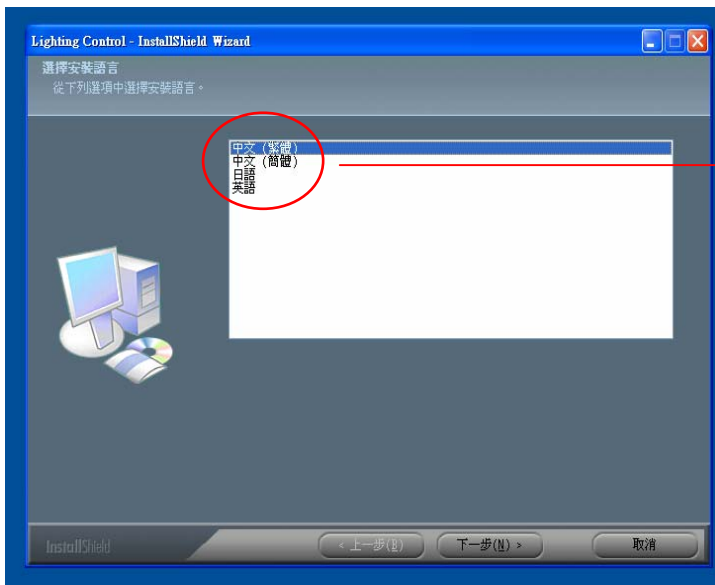

Traditional Chinese  
Simplified Chinese  
Japanese  
English

User can select the language from the list.

**STEP-3** After language selection, press Next and it will display as below,

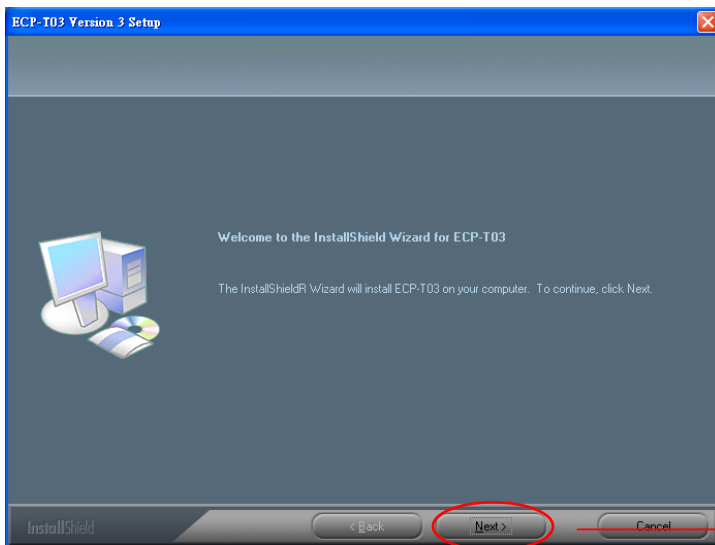

Next

Press Next again, it will display as below,

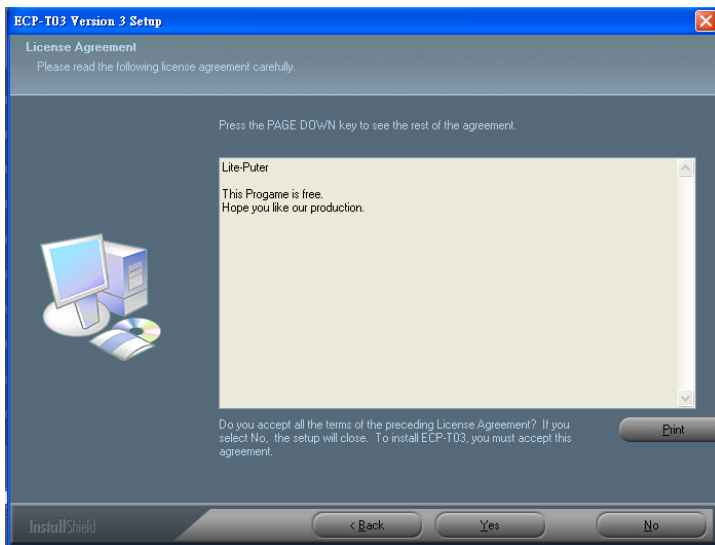

**STEP-4** Press Yes and it will display as below,

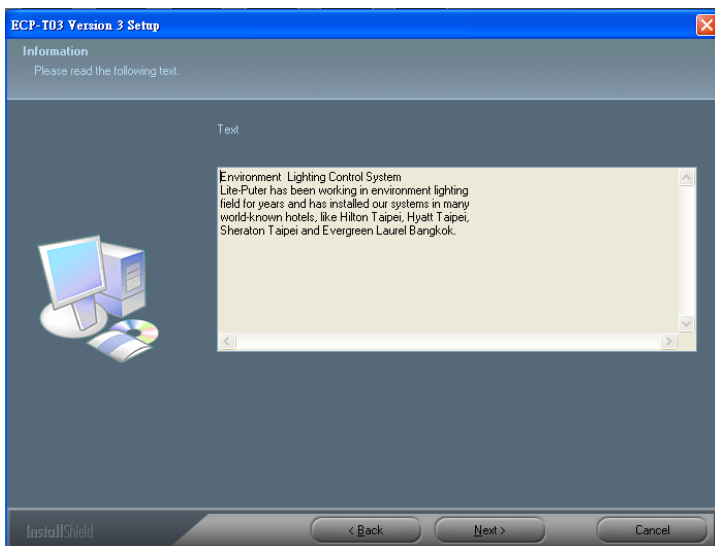

Press Next in the following steps,

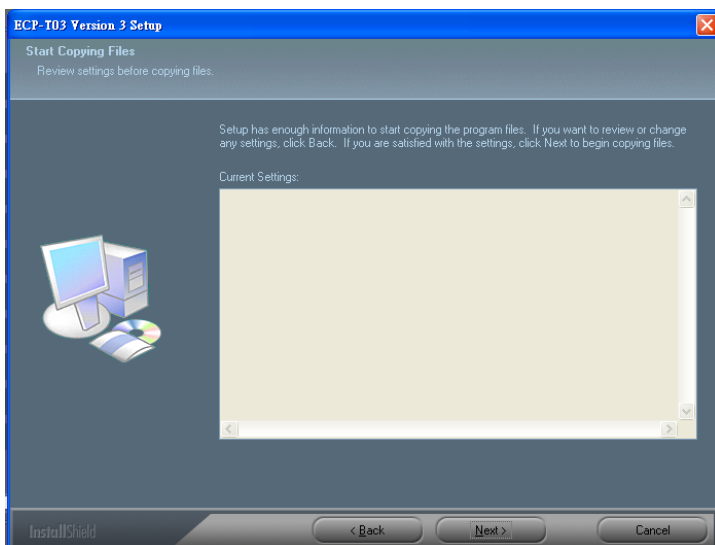
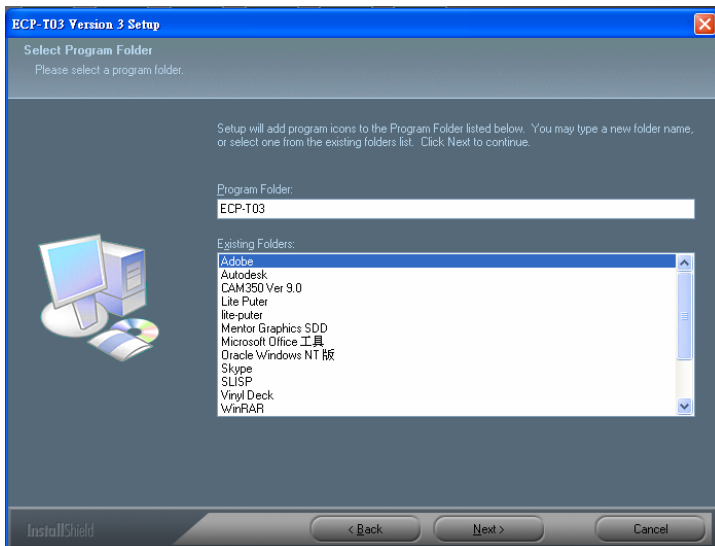
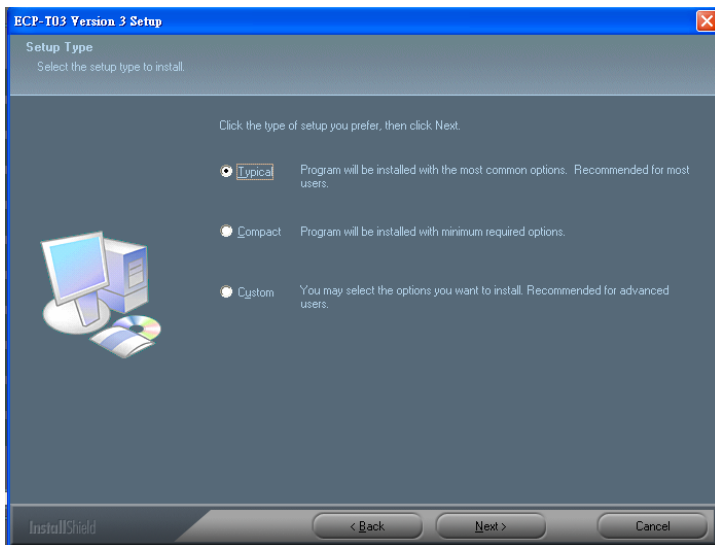

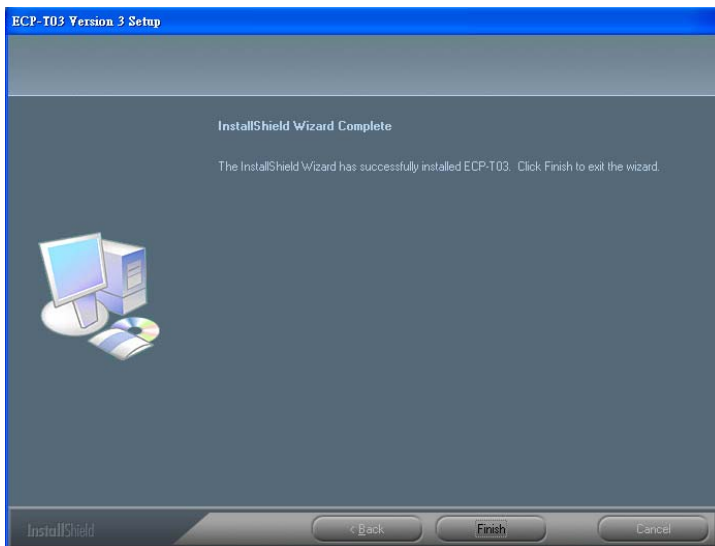
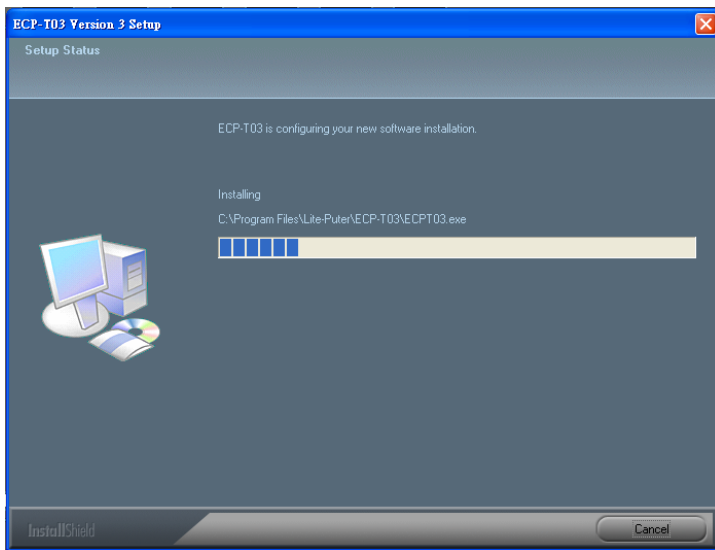

Press Finish and then installation is ok.

After installation is ok, there are 2 shortcuts on the desktop and all programs separately. It will display as below,

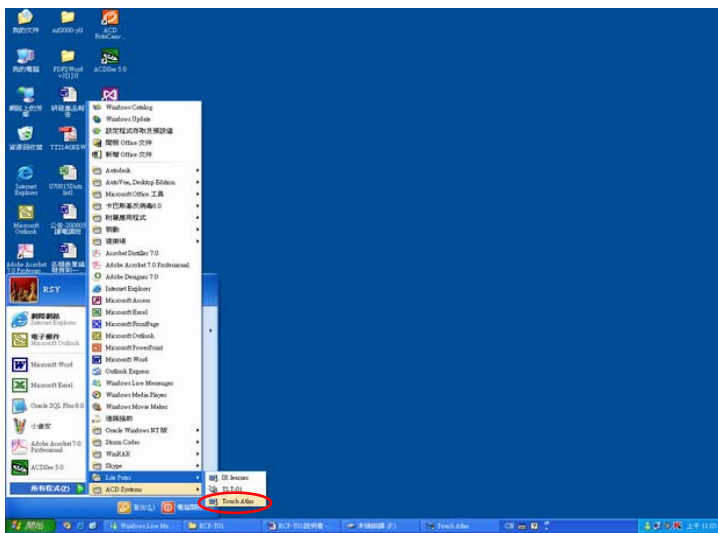
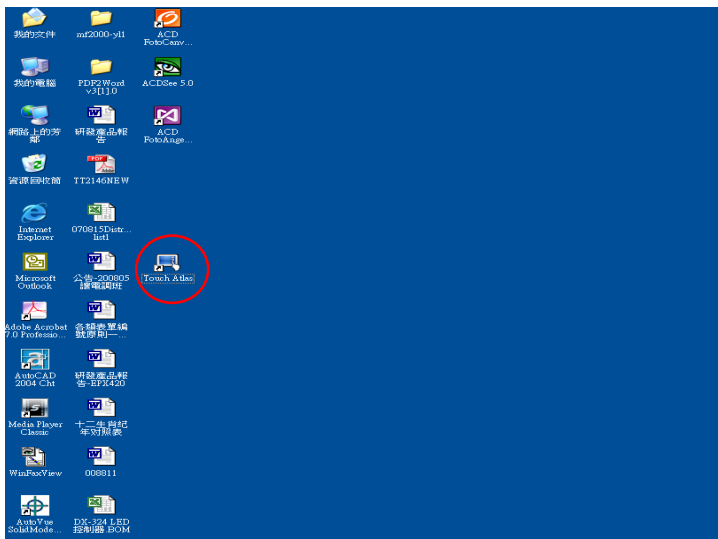

### 1-3 Device Driver Installation

After programming software installation, next step is device driver installation.

STEP-1 After install programming software correctly, go from desktop→my computer →disk C → PROGRAM FILES →LITE-PUTER →ECP-T03 to DRIVER and copy the DRIVER to the desktop . It will display as below,

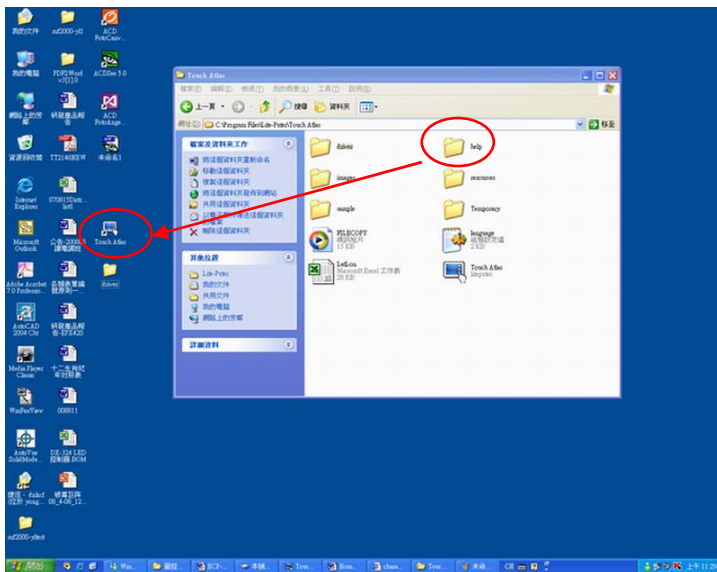

STEP-2 Connect the device with PC by USB line and it pops up the dialogue box as below,



Select "No, not this time" and it will display as below,

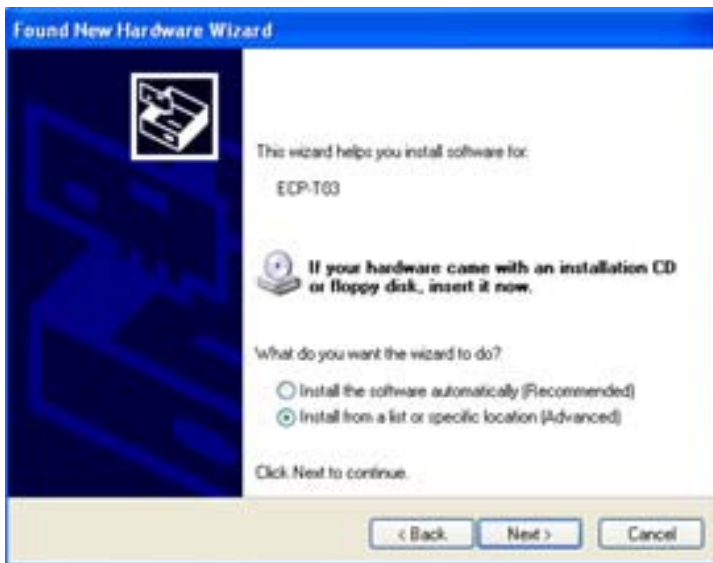

Press Next and it will display as below,



Fine the DRIVER file from the Desktop and select it.

**STEP-3** Press Next again and it will display as below,



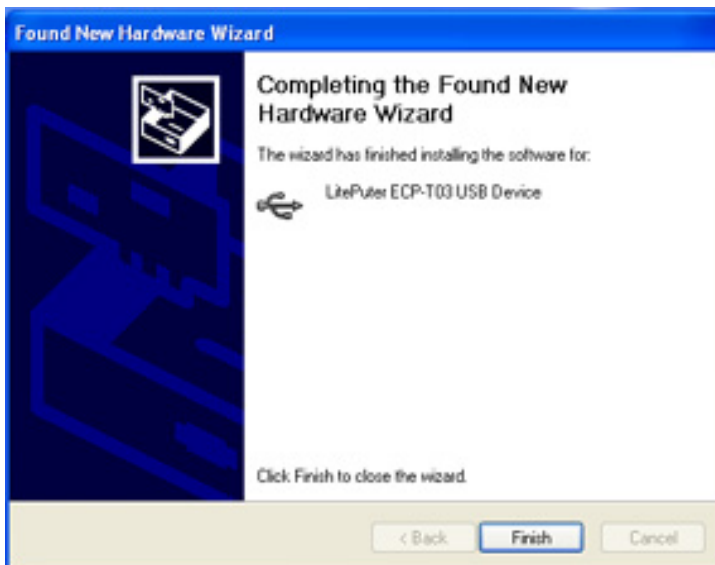

Press Finish and installation is ok.

## Chapter 2 · Programming Software Introduction

### 2-1 Connection between Device and Programming Software

When the user opens the programming software, it will display as below,  
Graph 1 : Device is unconnected with programming software.



Graph 2 : Device is connected with programming software.



Connect by USB





Connect by Lan 

## 2-2 Menu and Interface Introduction

### 2-2-1 Menu Introduction



File menu can create, open and save a file.

ECP-T03		
File (F)	Component (C)	
New Project	Ctrl+N	—Create new project
Open	Ctrl+O	—Open file
Save	Ctrl+S	—Save file
Save as		—Save as file
Exit	Ctrl+Q	—Exit the programming software

Component(c) menu can add button, label, clock picture and bar.

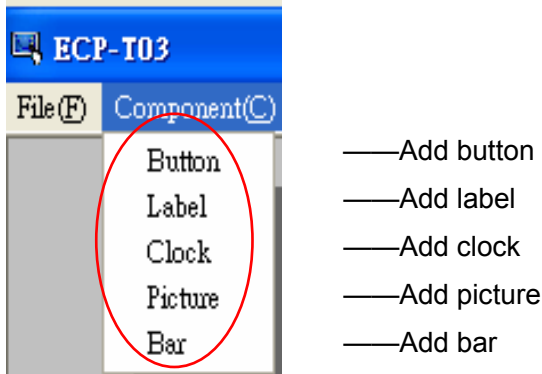

Format (F) menu can modify the component's position, size and space

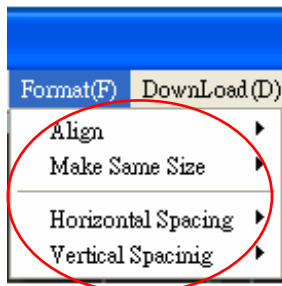

Align submenu include:

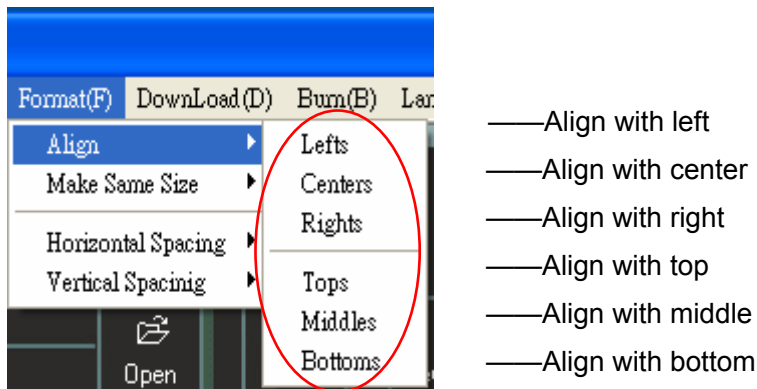

Make same size submenu include:

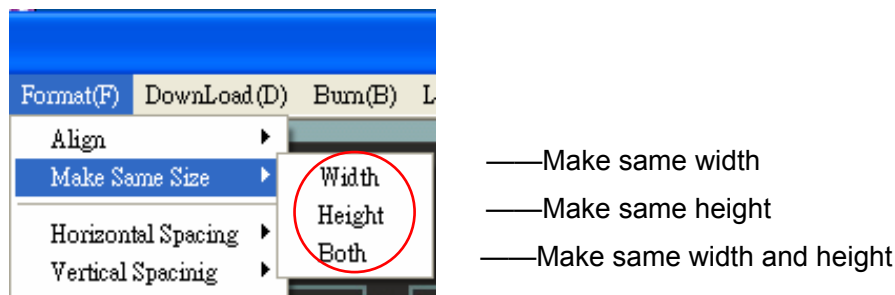

Horizontal Spacing submenu include:

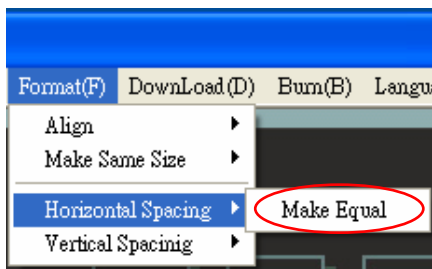

——make horizontal spacing equal

Vertical Spacing submenu include:

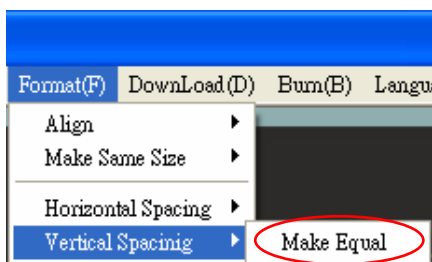

——make vertical spacing equal

DownLoad(D) menu ——Download the page and time to device.(Download the data programmed by the software to ECP-T03)

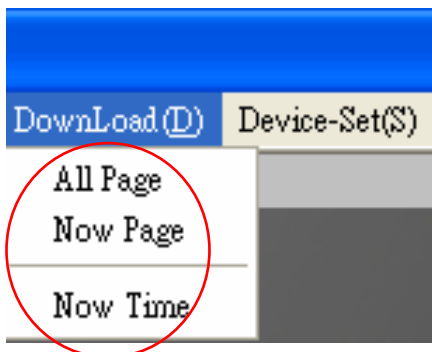

- Download all page
- Download current page
- Download current time

Device-Set(s) setting include: IP set, device description, password set and MAC address set.

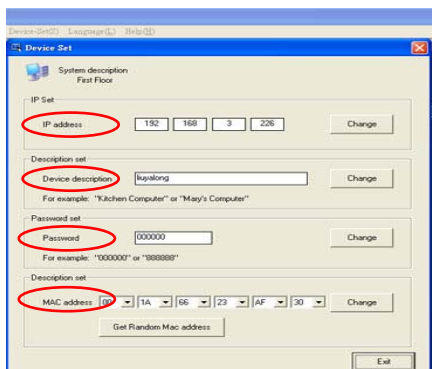

- IP set
- Device description
- Password set
- MAC address set

Language(L) menu can select the language.





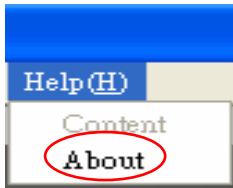

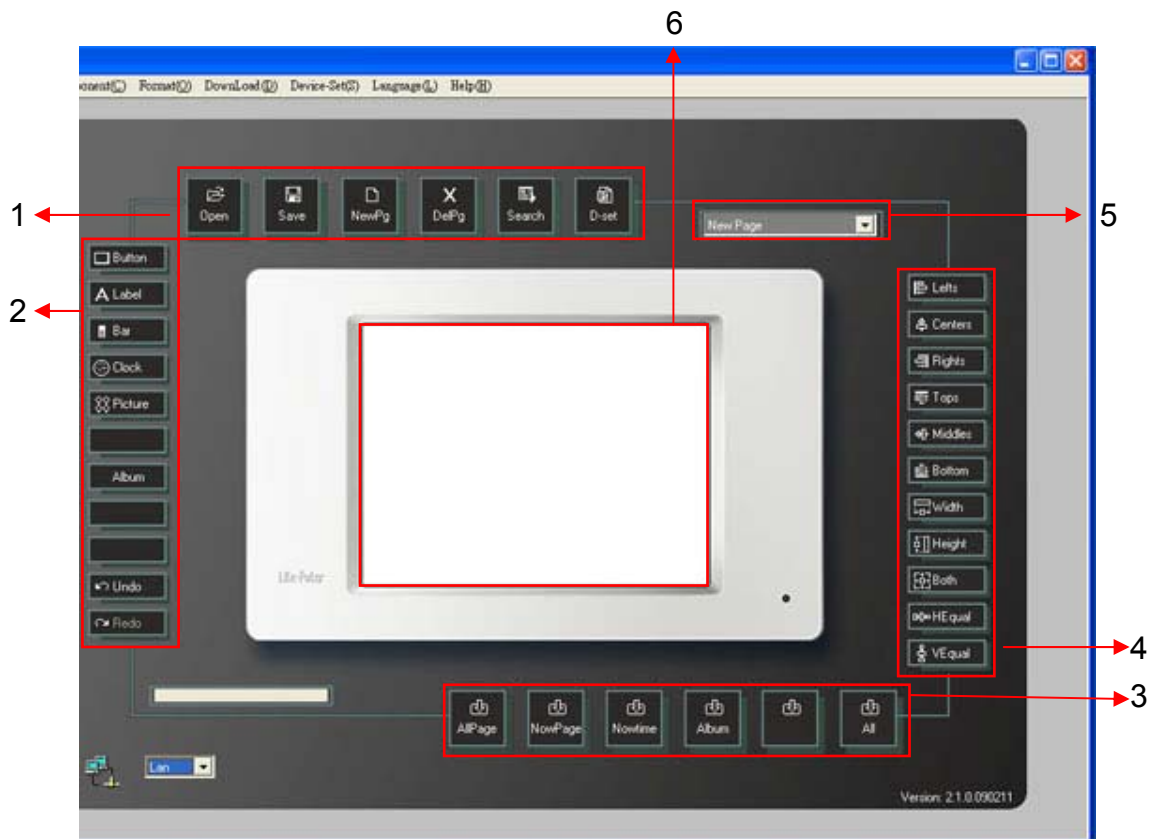

Help(H) menu has the software introduction.







## 2-2-2 Interface Introduction





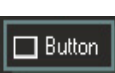

### 1button on interface introduction

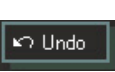
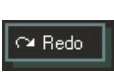
	Open file		Delete any page
	Save file		Search device's IP
	Create new page		Device setting





### 2button on interface introduction

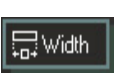

	Add button		Add clock
	Add label		Add picture
	Add bar		Album setting
	Undo the operation		Redo the operation

### 3button on interface introduction

	Download all page data to device		Download system time to device
	Download current page data to device		Download all data to device
	Download album photo to device		

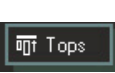
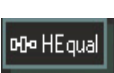
### 4.button on interface introduction

	Make component align with left		Make component have same width
	Make component align with center		Make component have same height
	Make component align with right		Make component have same width and height
	Make component align with top		Horizontal spacing equal

	Make component align with middle		Vertical spacing equal
	Make component align with bottom		Check select the page

5 — This area illustrates the component’s edited effect.

### 2-3 Component (button, label, bar, clock, picture) Operation

Page: a page is an assortment of soft keys and graphics that represents something understandable to the user. The pages all have something in common: the actual buttons and controls used. There are many different types of components you may see on a page, which includes button, label, bar, clock, picture and they must be edited on the pages.

Component: a graphical object display on a page. Component include button, label, bar clock and picture.

There are 5 kinds of components:

Button : The button is used for control something, you touch a button and something happens. You can turn on a light, recall a scene .A button can have the name of the device it controls written on it, or a picture. The buttons with different function, background, border can exit in same page. Please check the button examples as below,

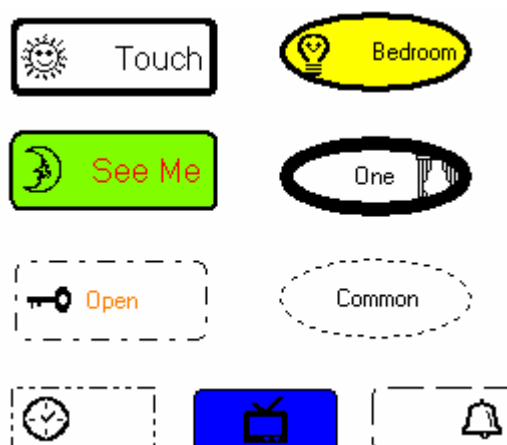

Buttons can have 4 control functions: page link, scene recall, channel dimming value control and data save&read.



Page link: press the button it will cause the display jump to another page.

Scene control: press the button it will recall the scenes of the controller device.

Channel dimming value control has 2 methods:

Two buttons (up and down): press the up button to increase the dimming value from 0-100% of the certain channels, press the down button to decrease the dimming Value from 100%-0 of the certain channels.

(The channel no. and zone no. is depend on the EDX system work with ECP-T03.)

One button: press the button it will call out the channel's dimming value.(for example: 50%.)

Data save&read: press the button it can read current channel's dimming value of the controller device and save the scene setting.

Label: label's used as the remake for the pages; it can mark the page no., page name and function.

Bar : A bar can be used to adjust the channel dimming value and display the value change from 0%-100%.

Picture: It has same notion and function as the button's.

Clock: Add the time display on the ECP-T03 .

## 2-3-1 Button Operation All the following steps must be continuous

### 2-3-1-1 Add Button

STEP-1 Open the programming software and it will display as below,

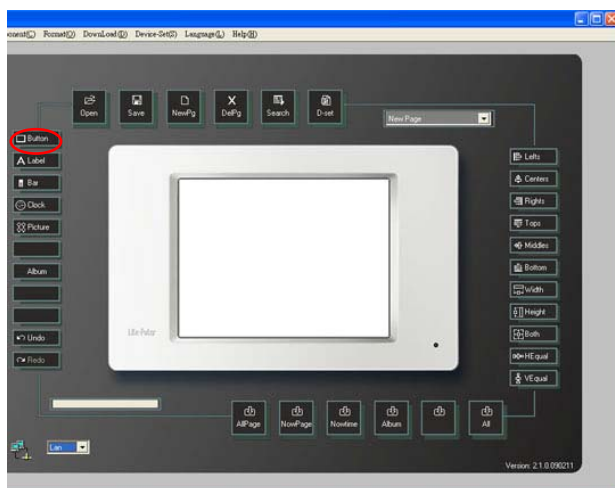

STEP-2 Press button key on the interface or use the Component(c) menu to add a button and it will display as below,

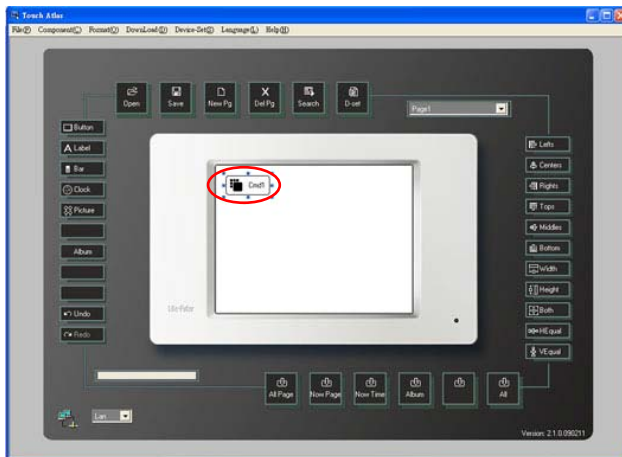

### 2-3-1-2 Button Property

STEP-3 After add a button then double click it. It will display as below,

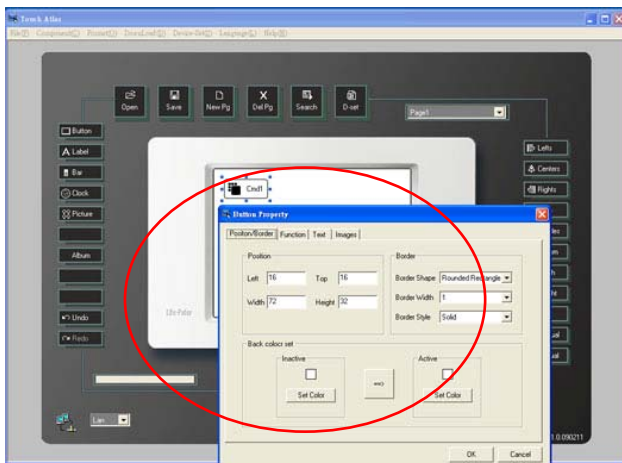

Dialogue box—define button property.

#### Text Setting

STEP-4 Select the Text property from the dialogue box and it will display as below,

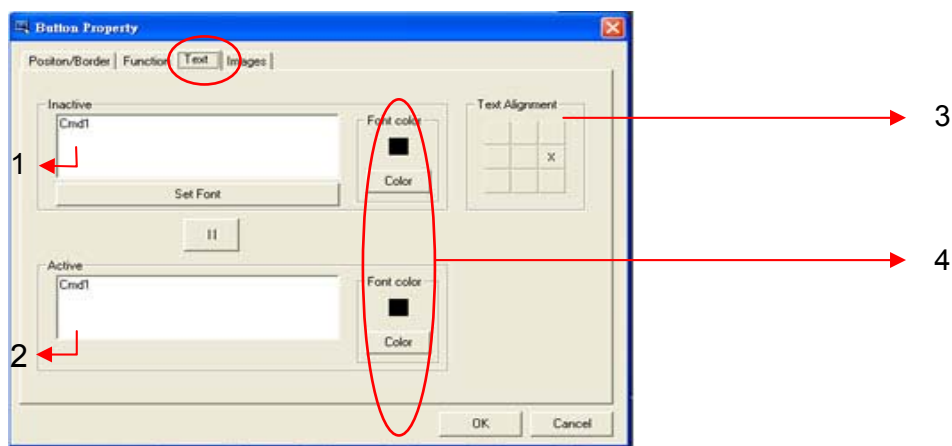

1--- Text display when the button on inactive status

2--- Text display when the button on active status

3--- Align the text position

4--- The text color display when the button on the inactive and active status

STEP-5 Key in the text into the inactive blank. For example, key in“ROOM ON”, into inactive blank and“ROOM OFF” into active blank.

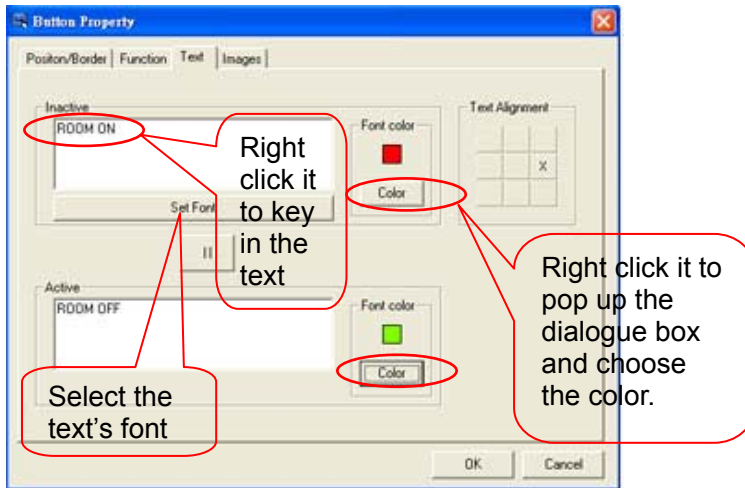

STEP-6 Use text alignment to choose text's position on the button. When the position's chosen, it will mark as "X".

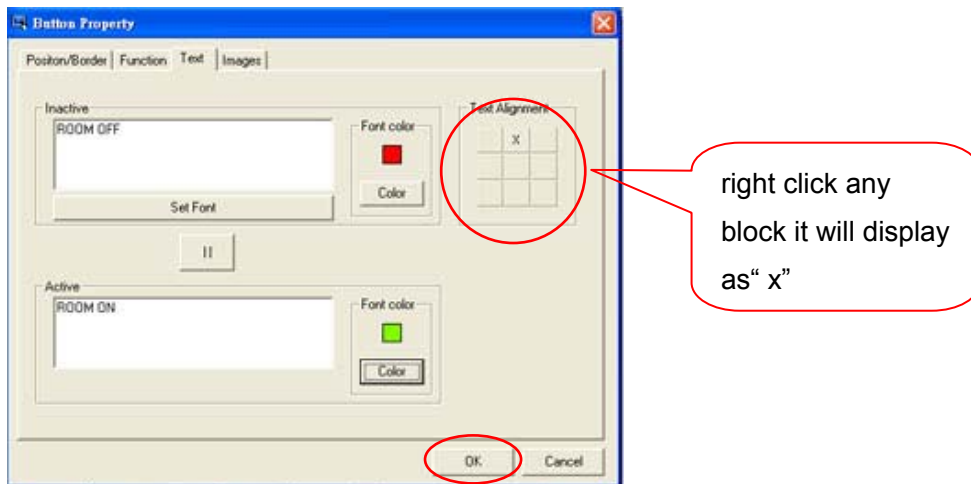

STEP-7 Press OK to save the text setting and it will display as below,

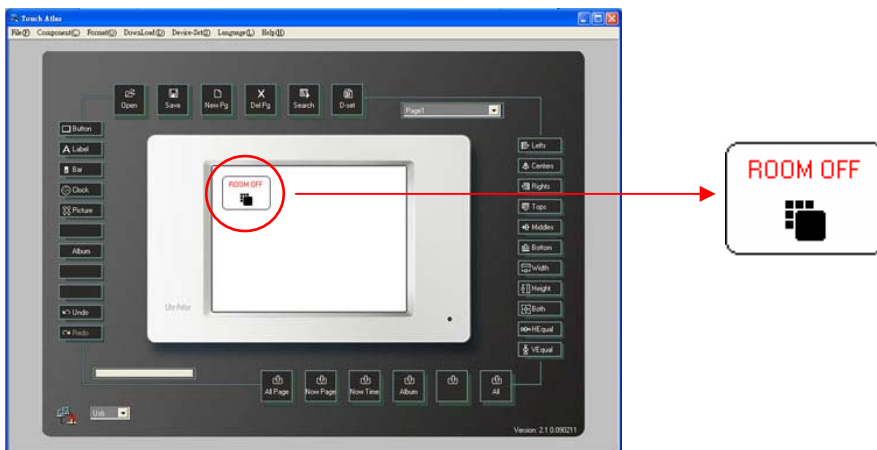

### Image Setting

STEP-8 Double click button again and select images property from the dialogue box. It will display as below,

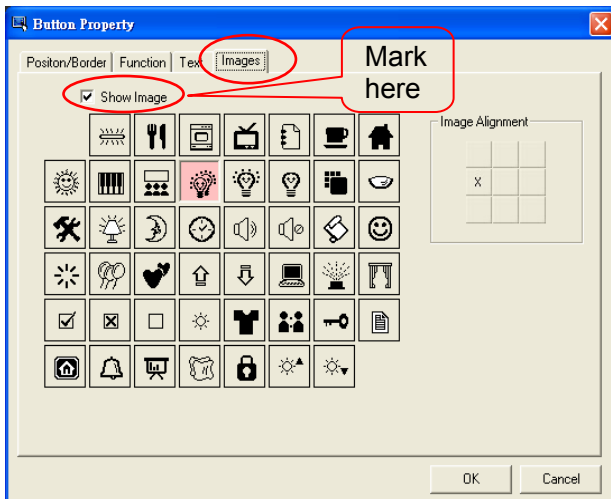

STEP-9 Right click any image below and it will display as below,

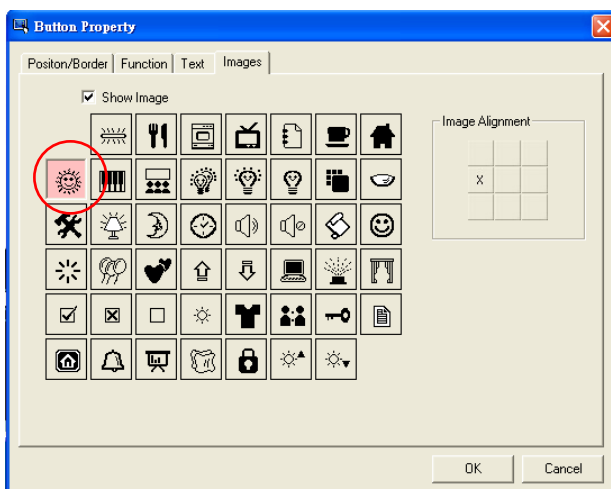

STEP-10 Use Image Alignment to choose image's position on the button. Please refer to the steps of text position setting.

STEP-11 Press OK to save the image setting and it will display as below,

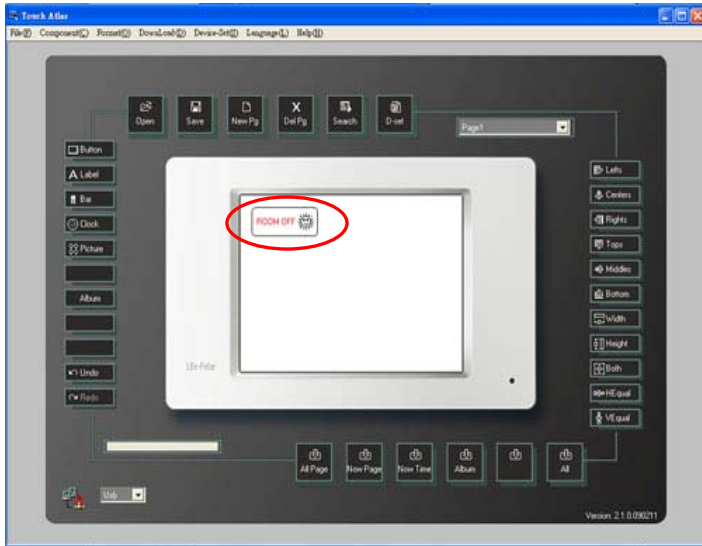

### Function Setting

STEP-12 Double click button again and select function property from the dialogue box. It will display as below,

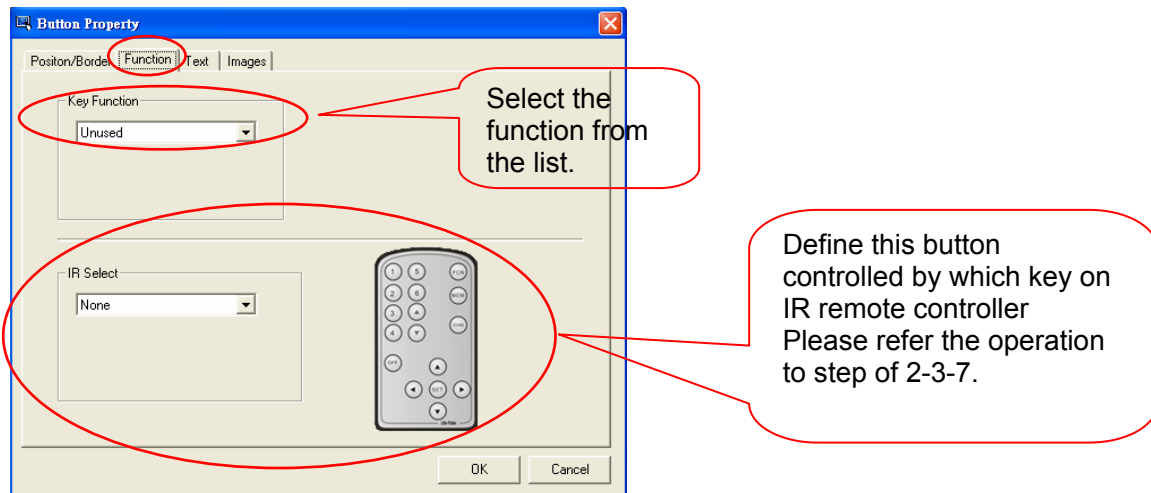

Function list as below,

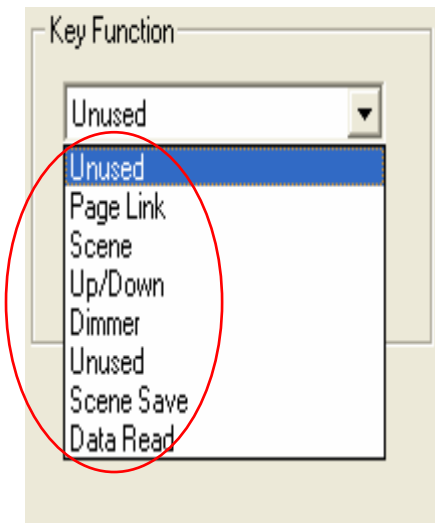

- set as unused button
- set as page link button
- set as scene recall button
- set as up/down dimmer button
- set as dimmer button
- set as spare button for other function
- set as scene save button
- set as read channel dimming value

After select the function from the list, please refer to the steps of 2-5 for the advanced setting.

**STEP-13** For example set the button function as Page Link and it will display as below,

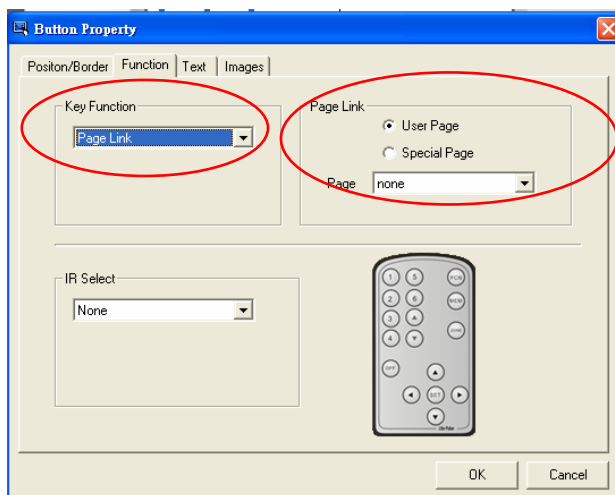

Those setting refer to steps of 2-5.

**STEP-14** Press OK to save the function setting.

Position/Border Setting

**STEP-15** Double click button again and select Position/Border property from the dialogue box. It will display as below,

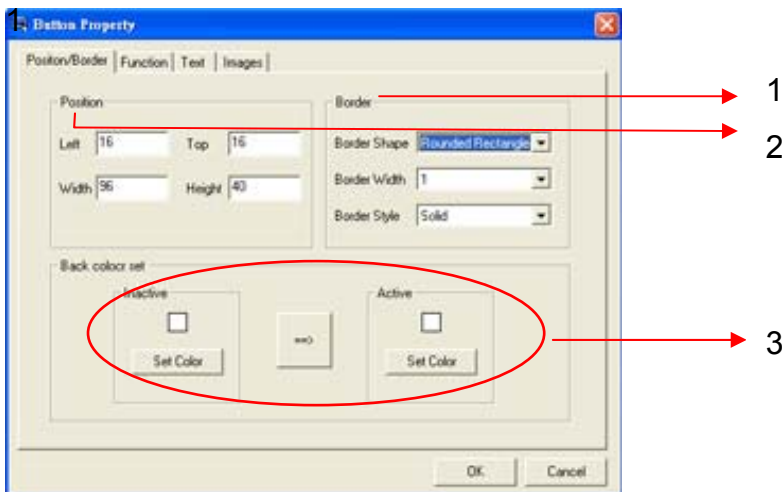

1--- Position and size setting

2--- Border setting

3--- The button color display when the button on the inactive and active status

Notice: Left/Top ——Button’s position on the illustration area.

Width/Height——Button’s width and height.

**STEP-16** Right click Left/Top/Width/Height blank to edit the number.

For example: Left/Top set as 0/0, Width/Height set as 80/60 and set the button as green when it on the inactive status; set the button as blue, when it on the active status.

**STEP-17** Right click Left/Top/Width/Height blank to key in the number and it will display as below,

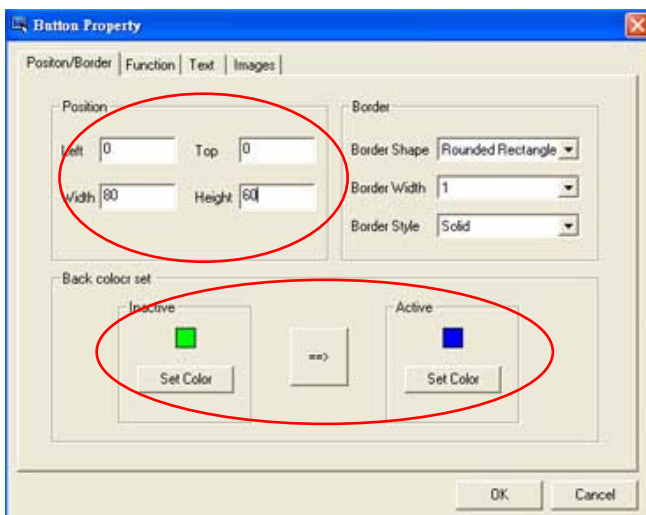

Border setting:

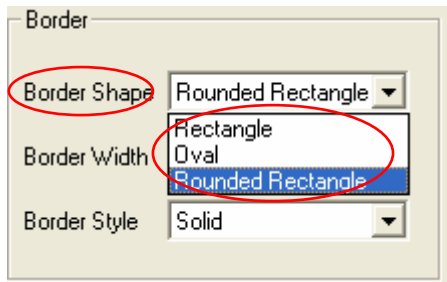

Border Shape includes:

- Rectangle
- Oval
- Rounded Rectangle

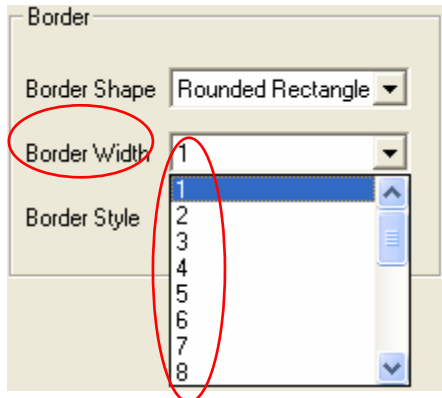

Select border width from the list

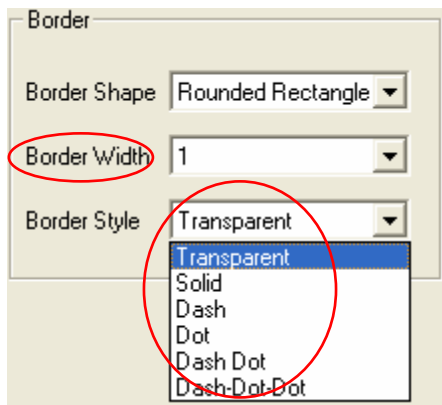

Border Style includes:

- Transparent
- Solid
- Dash
- Dot
- Dash Dot
- Dash-Dot- Dot

Notice : Before the style selection, border width must be set as 1 at least.

For example: Set the Border Shape as Oval, Border width as 6, and Border Style as Dash.

**STEP-18** Right click the Border Shape/Border width/Border Style list to choose the right item.



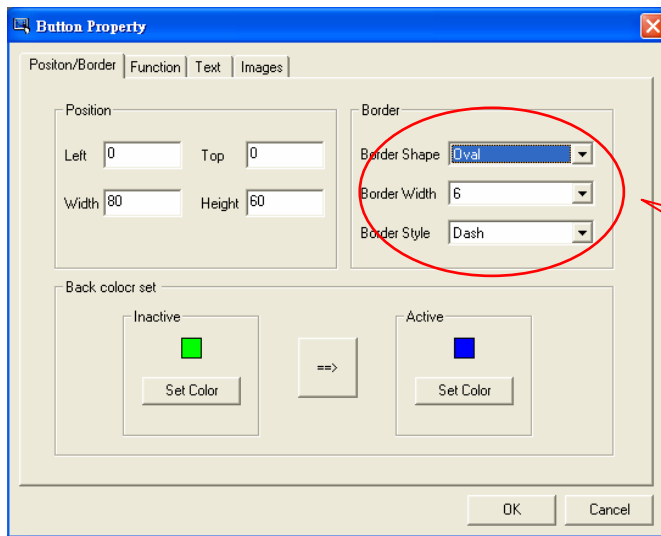

Set Border Width as 6,  
Set Border Style as  
Dash

STEP-20 Press OK to save the position /border setting and it will display as below,

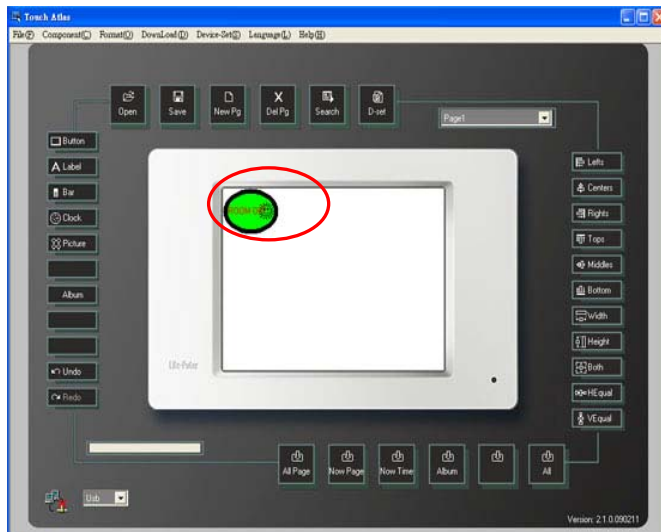

## 2-3-2 Label Operation (All the following steps must be continuous)

### 2-3-2-1 Add Label

STEP-1 Open the programming software.

STEP-2 Press label key on the interface or use the Component(c) menu to add a Label and it will display as below,

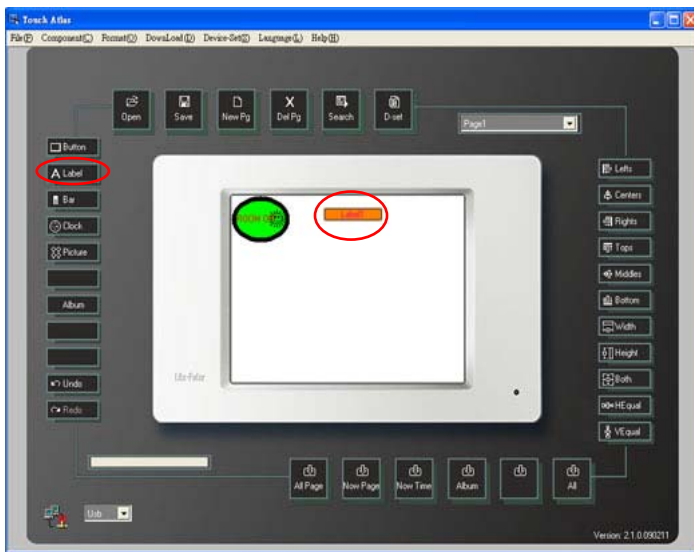

### 2-3-2-2 Label Property

STEP-3 After add a label then double click it. It will display as below,

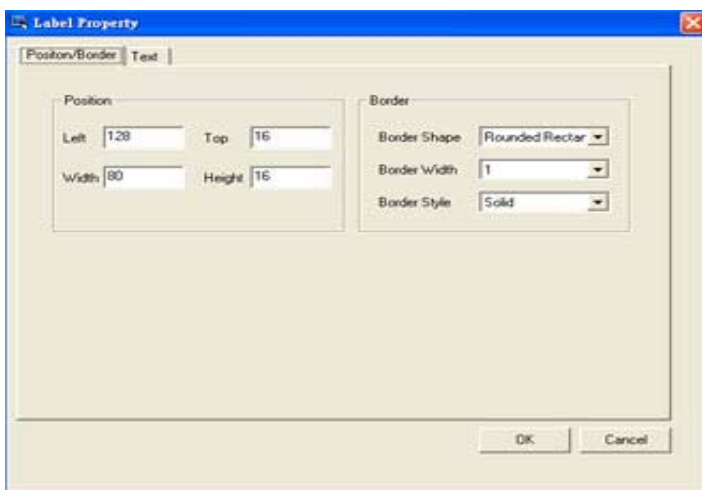

Dialogue box—define label property.

Text setting

STEP-4 Select the Text property from the dialogue box and it will display as below,

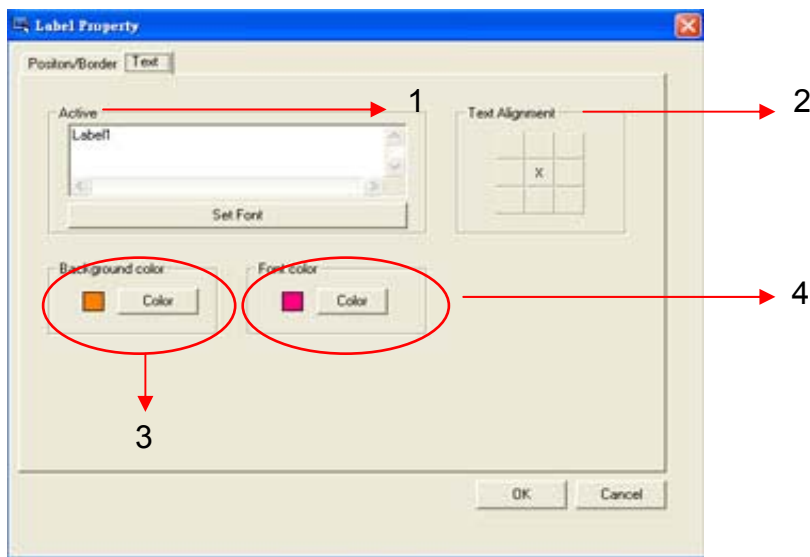

- 1--- Text display on label
- 2--- Align the text position
- 3--- Background color setting
- 4--- Text color setting

Please refer to the STEP-5 ~ STEP-7 of button's text setting to finish label's .

Position/Border Setting

STEP-5 Double click label again and select Position/Border property from the dialogue box. It will display as below,

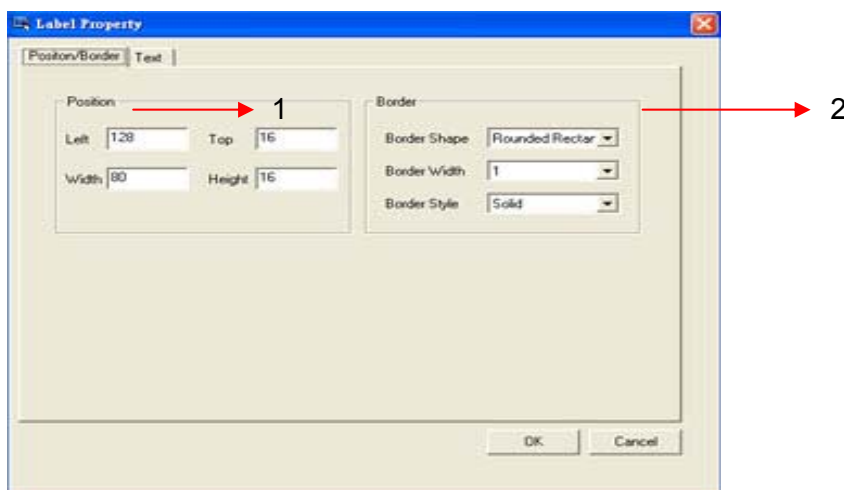

- 1--- Position and size setting
- 2--- Border setting

Please refer to theSTEP-17 ~ STEP-20 of button's Position/Border Setting to finish label's .

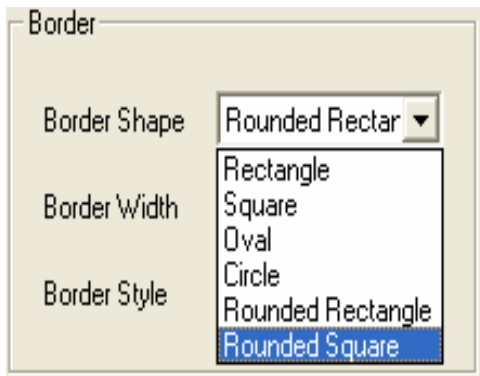

Border Shape include:

- Rectangle
- Square
- Oval
- Circle
- Rounded Rectangle
- Rounded Square

### 2-3-3 Bar Operation

#### 2-3-3-1 Add Bar

STEP-1 Open the programming software.

STEP-2 Press bar key on the interface or use the Component(c) menu to add a bar and it will display as below,

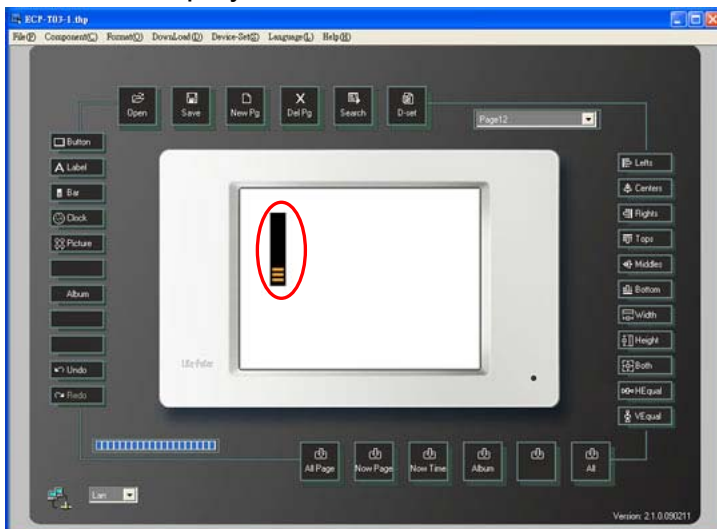

#### 2-3-3-2 Bar Property

STEP-3 After add a bar then double click it. It will display as below,

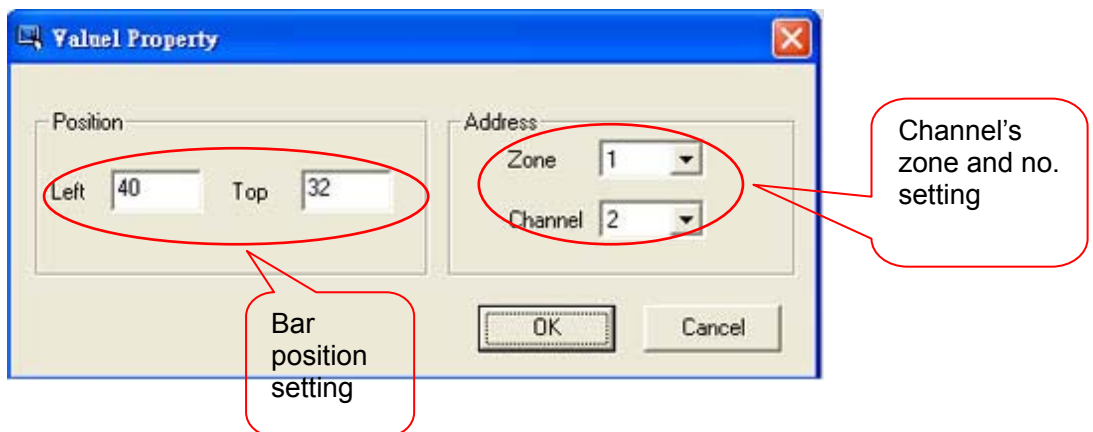

Dialogue box—define label property.

1--- Position setting

2---Channel's zone and no. setting

STEP-4 Press OK to save the setting.

## 2-3-4 Clock Operation

### 2-3-4-1 Add Clock

STEP-1 Open the programming software.

STEP-2 Press clock key on the interface or use the Component(c) menu to add a clock and it will display as below,

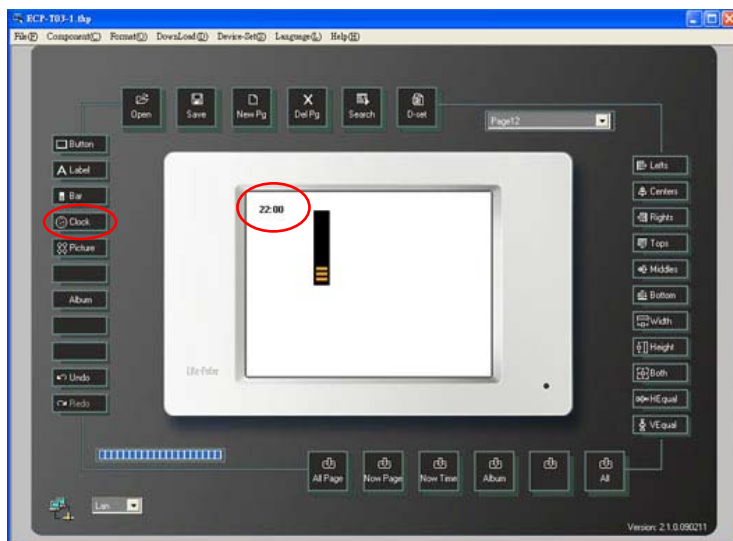

The clock is the system time and user can't modify it.

## 2-3-5 Picture Operation

### 2-3-5-1 Add Picture

STEP-1 Open the programming software.

STEP-2 Press picture key on the interface or use the Component(c) menu to add a picture and it will display as below,

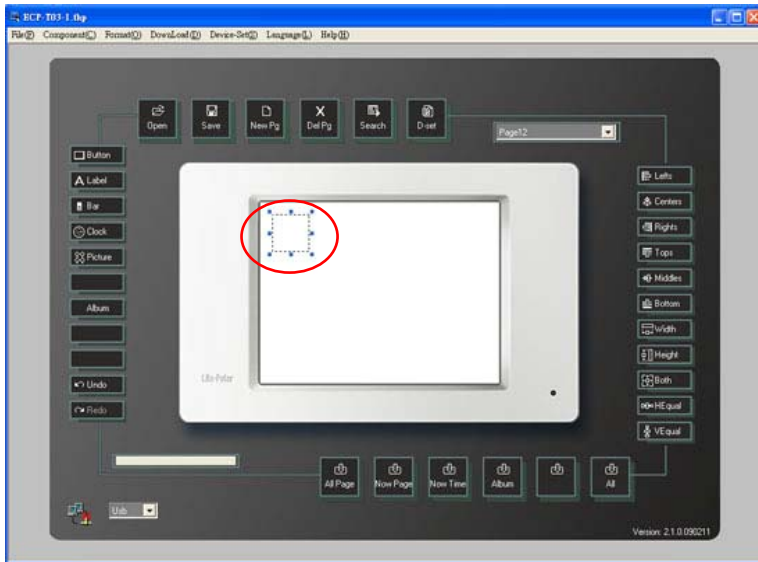

### 2-3-5-2 Picture Property

Position/Picture Setting

STEP-3 After add a picture then double click it. It will display as below,

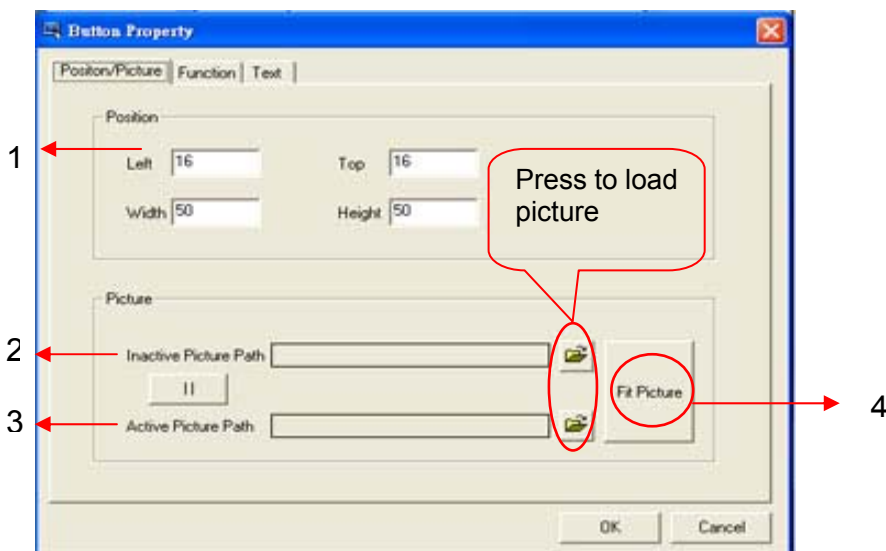

1--- Position and size setting

2--- Inactive picture path: picture display when the picture on inactive status.

3--- Active picture path: picture display when the picture on active status.

4---make the photo as the same size as picture on the illustration area.

### Text Setting

**STEP-4** Double click picture again and select text property from the dialogue box. It will display as below,

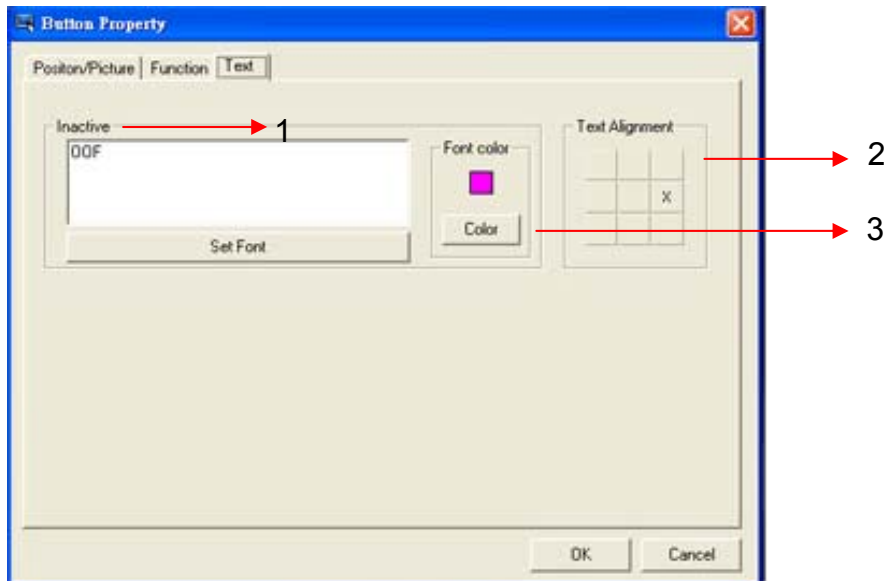

1--- Text display when picture on inactive status

2--- Align the text position

3--- text color

### Function Setting

**STEP-5** Double click picture again and select text property from the dialogue box. It will display as below,

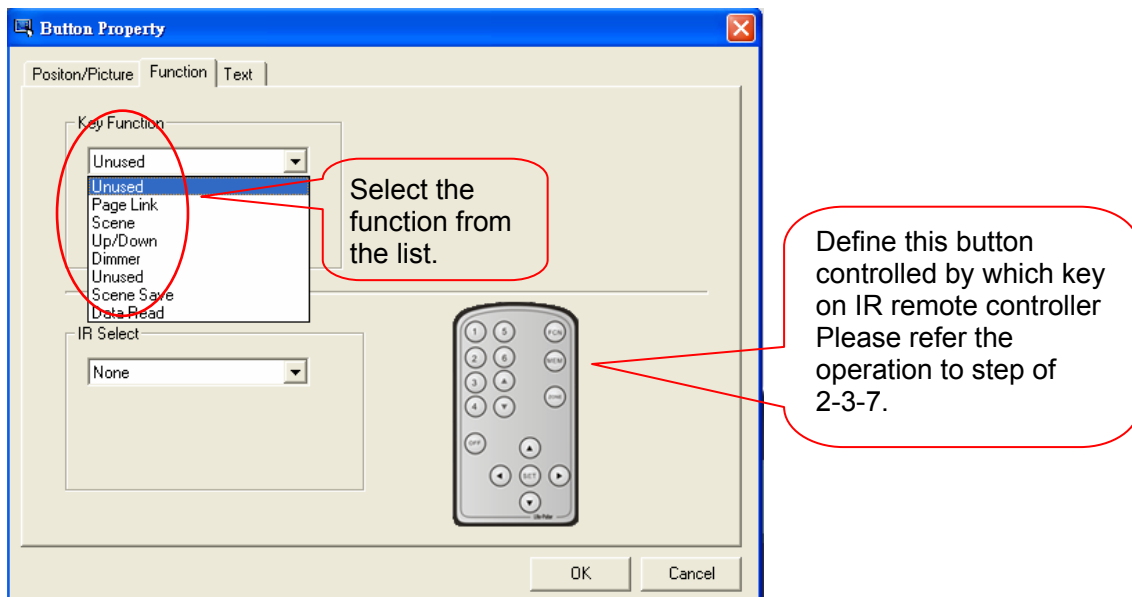

**STEP-6** Press Ok to save the setting.

Notice: User can drag the mouse to change the button, Label, Bar's position and size directly.

## 2-3-6 Album Operation

Album-----Load the photo to Digital Photo Frame. (19 photos at most)

**STEP-1** Open the programming software.

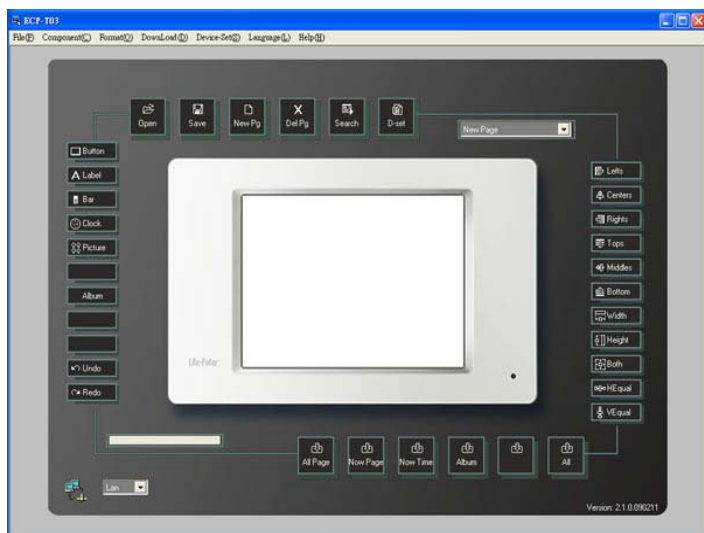

**STEP-2** Press  , it will display as below,



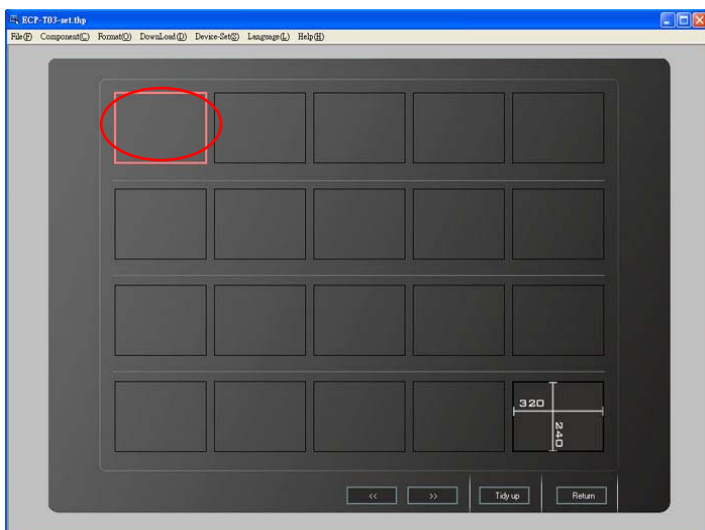

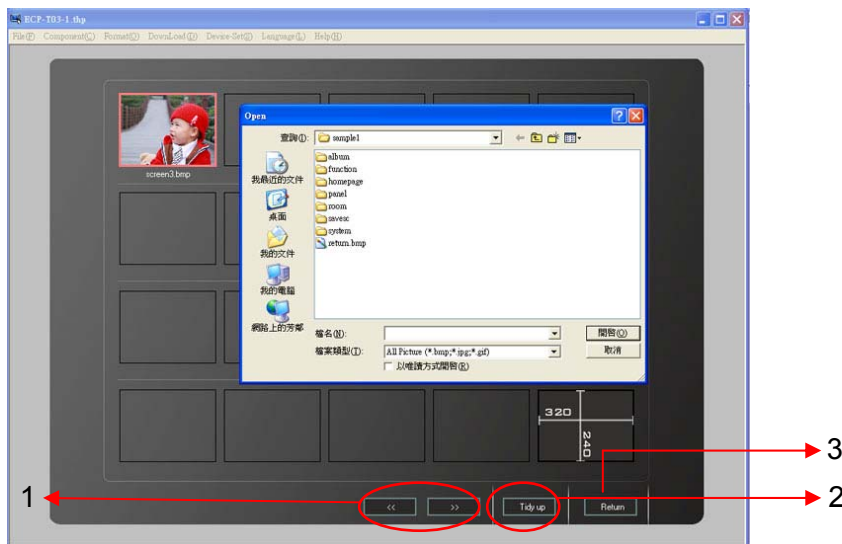

It can load 19 photos at most; the last one is the size display only.

**STEP-4** Double click any frame to load the photo and it will display as below,

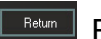

- 1---   Modify photo's position: remove the photo to last or next frame.
- 2---  Tidy up the photo's sequence. (When cancel one or more photos, it can remake the sequence. )
- 3---  Exit the Album operation.

### 2-3-7 Button, Picture's IR remote control

Notice :

Only button and picture component of ECP-T03 can accept IR remote control. The IR remote control setting of button and picture is the same, we only take button's IR remote control setting as a example,

**STEP-1** On the current Page, press button key on the interface or use the

Component(c) menu to add a button and it will display as below,

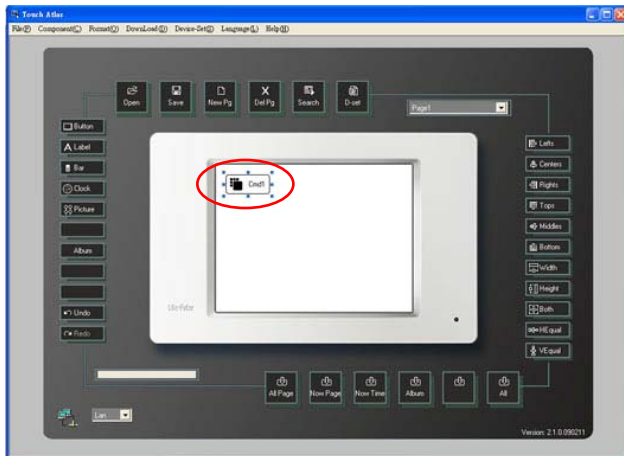

STEP-2 After add a button then double click it. It will display as below,

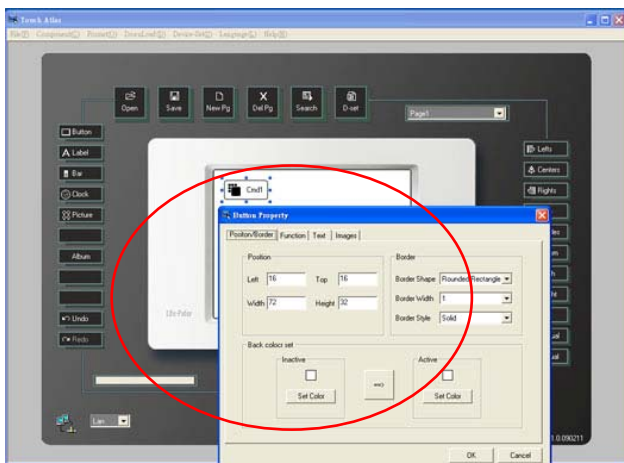

STEP-3 Select function property from the dialog box and it will display as below,

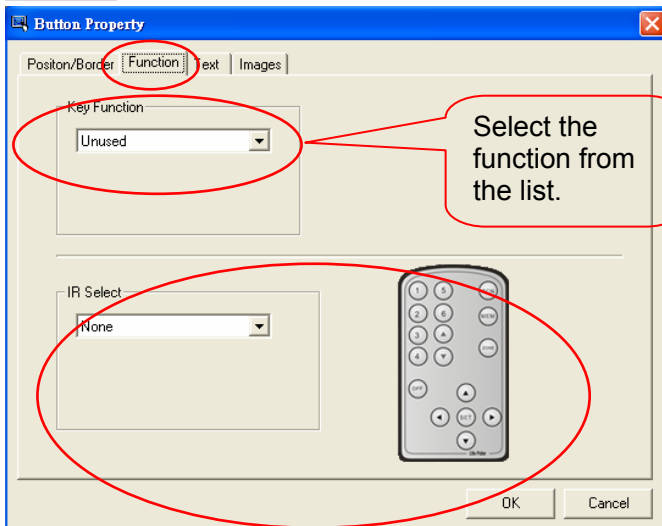

Button's Key Function setting, please refer to step of 2-3-1.

STEP-4 For example, select button's function as scene and choose the scene 01 of

zone 1 to be controlled by this button. It will display as below,

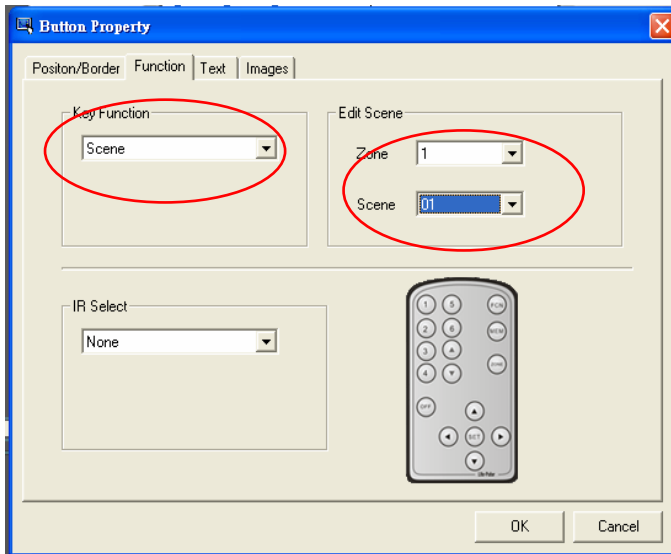

**STEP-5** Select the key on the IR remote controller corresponded to this button. For example, set this button corresponds to the FCN key on the IR remote controller and it will display as below,

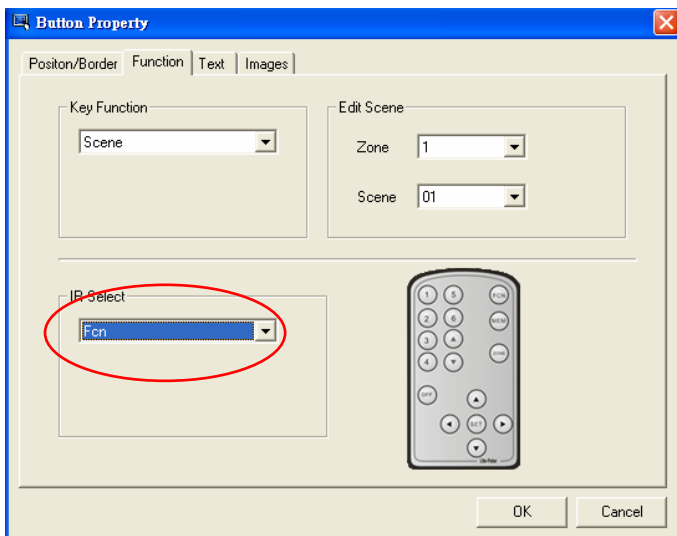

Press FCN key on the remote controller, ECP-T03 will call out the scene 01 of zone 1.

**STEP-6** Press OK to save the setting.

Notice: The key on the IR remote controller can be set to recall any function of the button. The remake on the IR remote controller key is different from the actual function set in ECP-T03 it recalls.

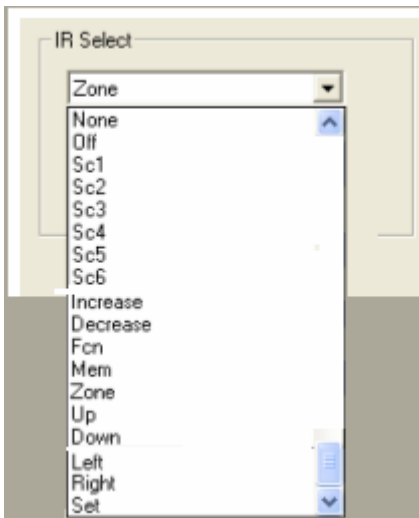

IR Select

All the key on the IR remote controller.

## 2-4 Page Operation

### 2-4-1 Page( User page) Operation

STEP-1 Open the programming software.

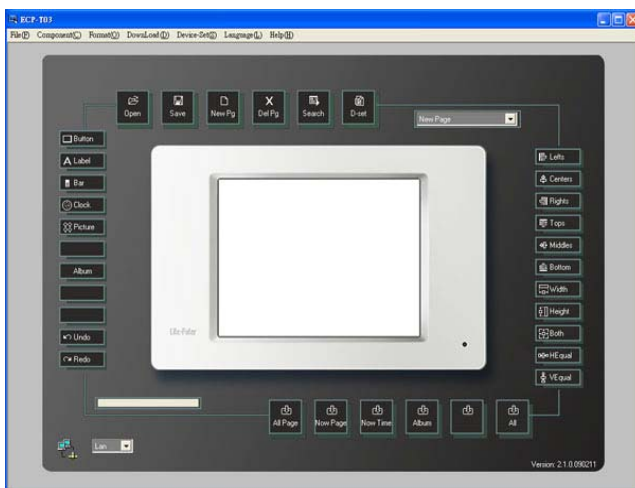

STEP-2 From File menu—New project to the New Page.

STEP-3 Then press  to add more pages and it will display as below,

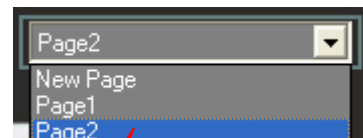
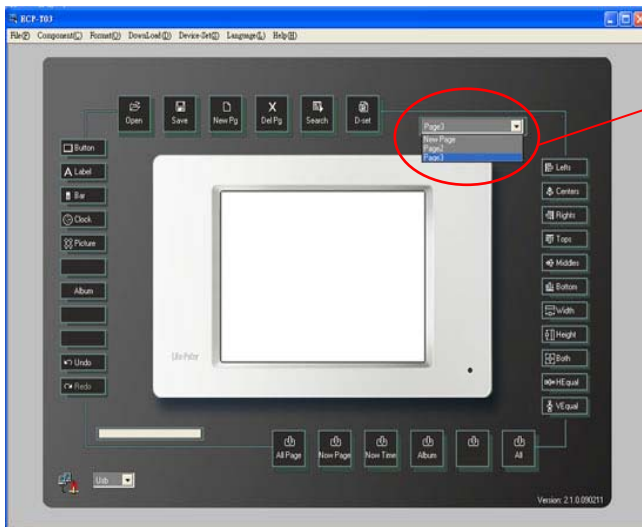

Shift pages from the list.

Take the New Page setting as example.

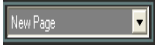
STEP-4 From the list  to shift to New Page and double click the page .It will display as below,

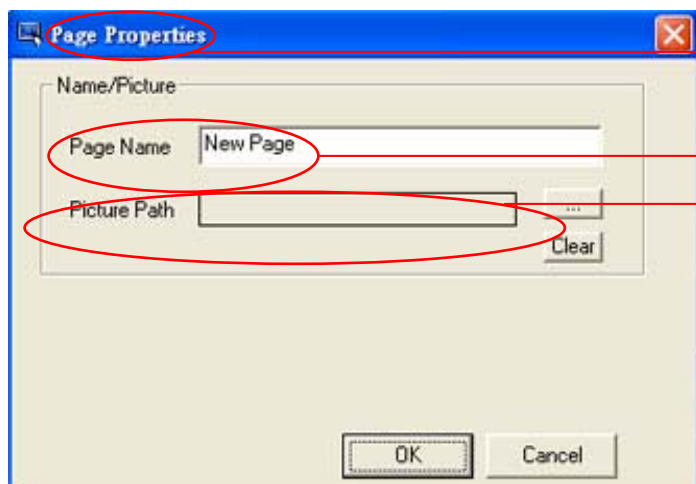

Page Properties Dialogue Box

Give a name to current page

Add or clear the background picture of current page

STEP-5 Click the page name blank and change “New Page” to “SC1”.It will display as below,

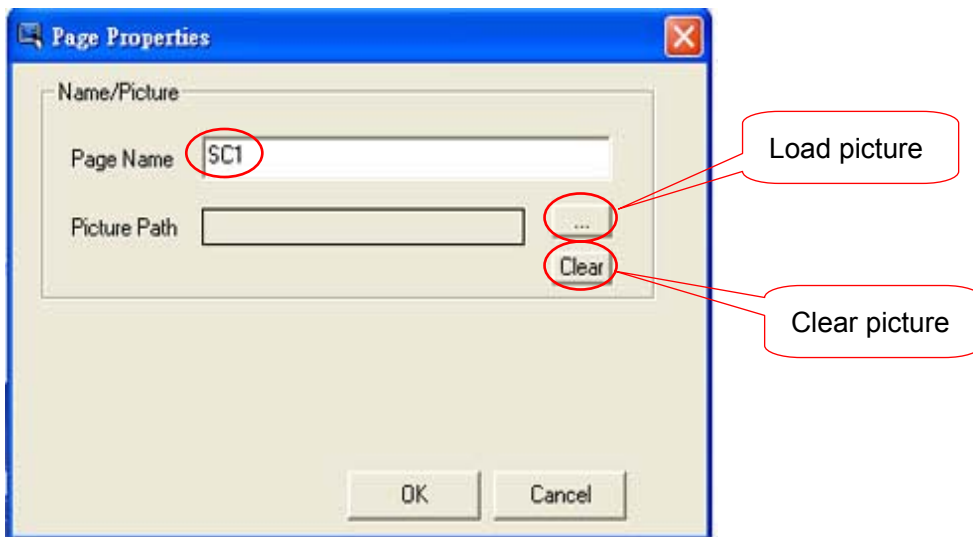

STEP-6 Press  it will display as below,

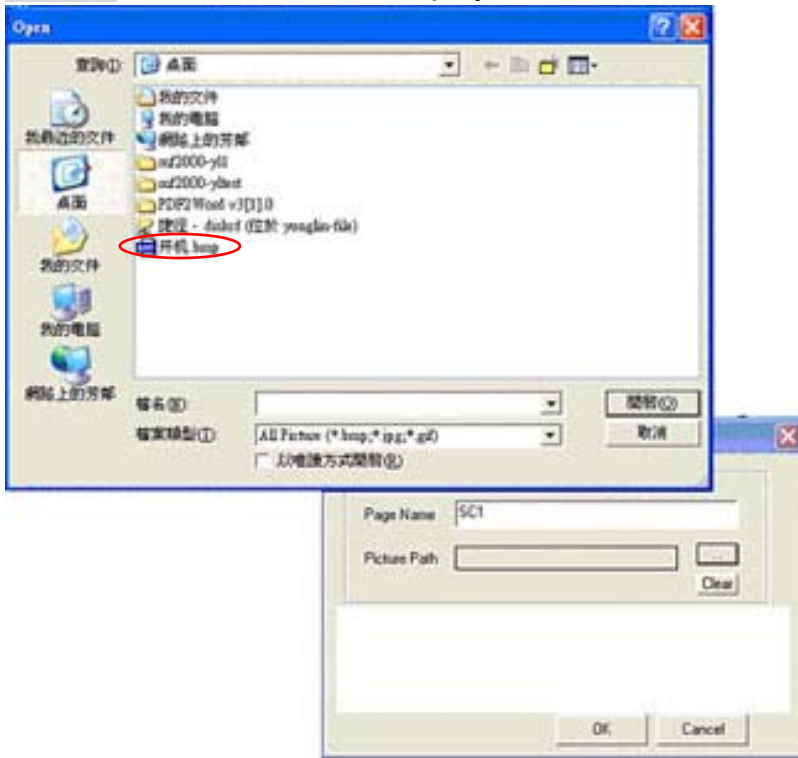

STEP-7 Double click the picture name you want to load and it will display as below,

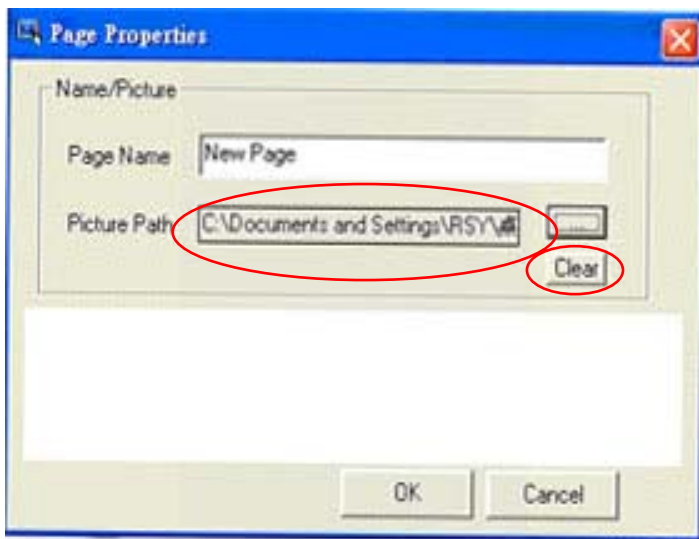

Press Clear to cancel the picture selection.

STEP-8 Press OK to save the setting.

### 2-4-2. Built –in Function (Special Page)Operation

Notice: User page: the notion of user page is the same as the Page’s. (Please refer to the explanation under 2-3 Component Operation.

Special page: Actually they are the defaulted built-in function pages and can be set on the Button Property dialogue box. If you press the button, it can jump to certain built-in function pages.

Built-in functions include backlight set, voice set, clock set, schedule set/preview and password protection.

The built- in function page as below,

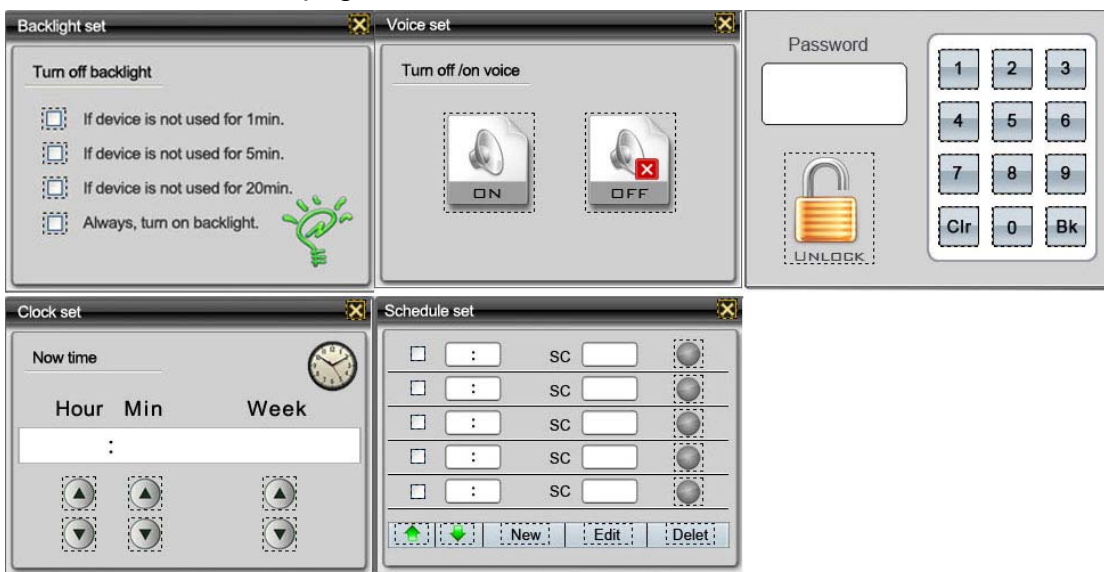

Take backlight set and voice set as example.

Backlight Set

STEP-1 Open the programming software

STEP-2 From File menu—New project to the New Page.

STEP-3 Press button key on the interface or use the Component(c) menu to add a button.

STEP-4 Double click the button and the button property dialogue box pops up.

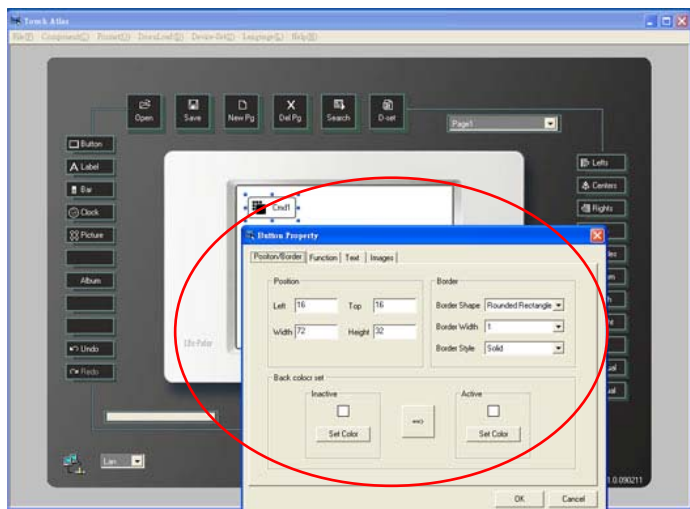

STEP-5 Select the function property from the dialogue box and it will display as below,

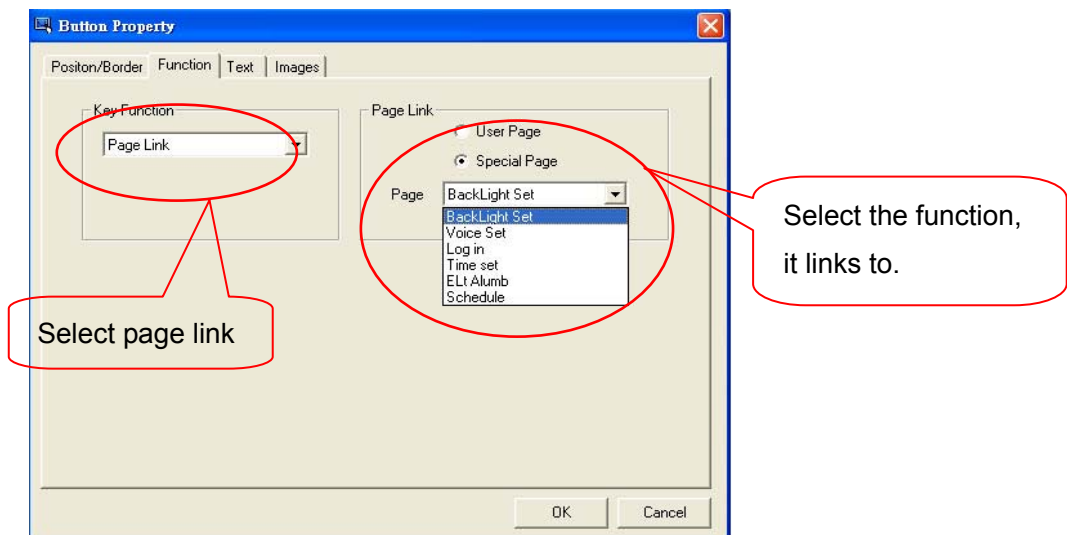

STEP-6 Select the Page Link from key function list, mark the circle beside Special Page of Page Link column and select Backlight set from the page list. It will display as below,



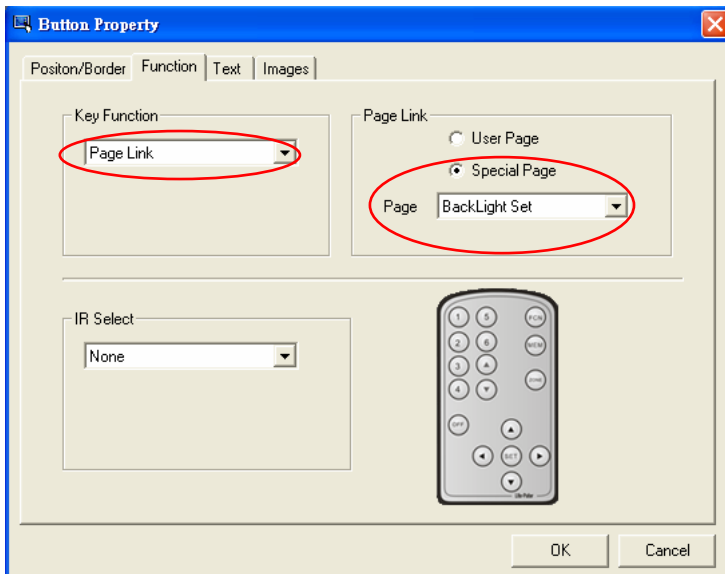

The setting of Text, Images, Positon/Border Property, please refer to the steps of 2-3-1. The button can be linked to following built-in function pages,

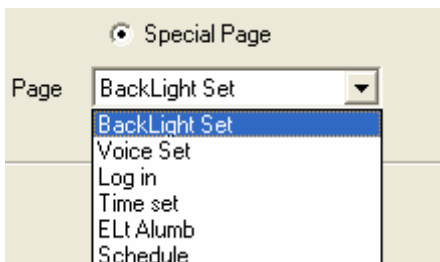

- Backlight set page
- Voice set page
- Password protection page
- Clock set page
- Digital photo frame page
- Schedule set page

**STEP-7** Press OK to save the setting.

After setting and press the Button, the Backlight set page will come out as below. User can select one from the four options.

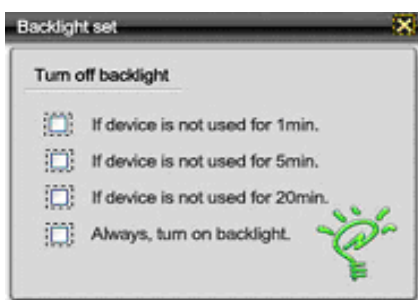

### Voice Set

**STEP-8** Add one more button on the same page (New Page), then double click the button and the button property dialogue box pops up.

**STEP-9** On the function property, select the Page Link from key function list, mark the circle beside Special Page of Page Link column and select Voice set from the page list. It displays as below,

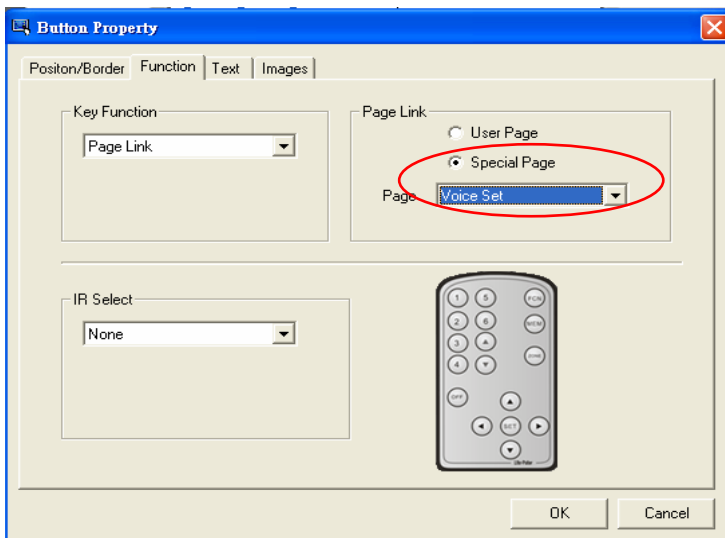

**STEP-10** Press OK to save the setting.

After setting and press the button, the Voice Set page will come out as below. User can select turn on/off the voice.



The setting of clock set page, password protection page and schedule set page, please refer to the steps backlight set and voice set.

## 2-5 Button's Advanced Setting

Button's advanced setting is the detailed description of the **STEP-12** to **STEP-13** of

### 2-3-1 Button Operation

Double click button and select function property from the dialogue box. It will display as below,

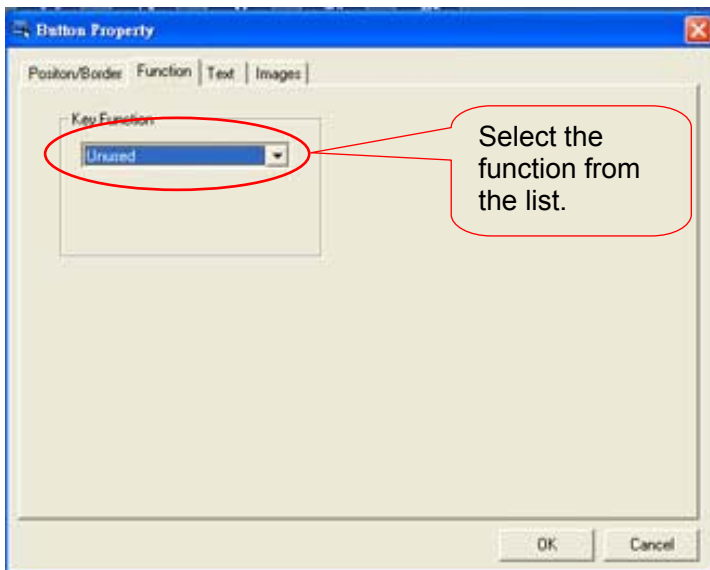

Function list as below,

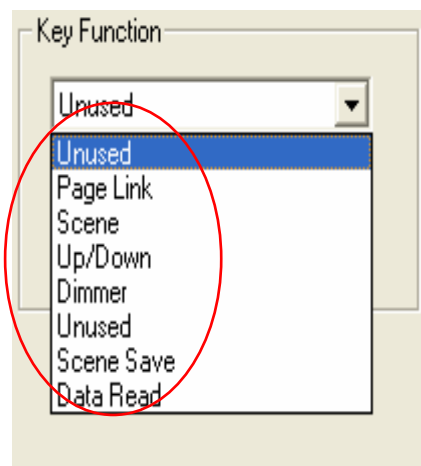

- set as unused button
- set as page link button
- set as scene recall button
- set as up/down dimmer button
- set as dimmer button
- set as spare button for other function
- set as scene save button
- set as read channel dimming value

a. **Unused** ——set the Button as useless

b. **Page Link** ——press the button, it will jump to other pages.

Select Page Link from button function list, it displays as below,

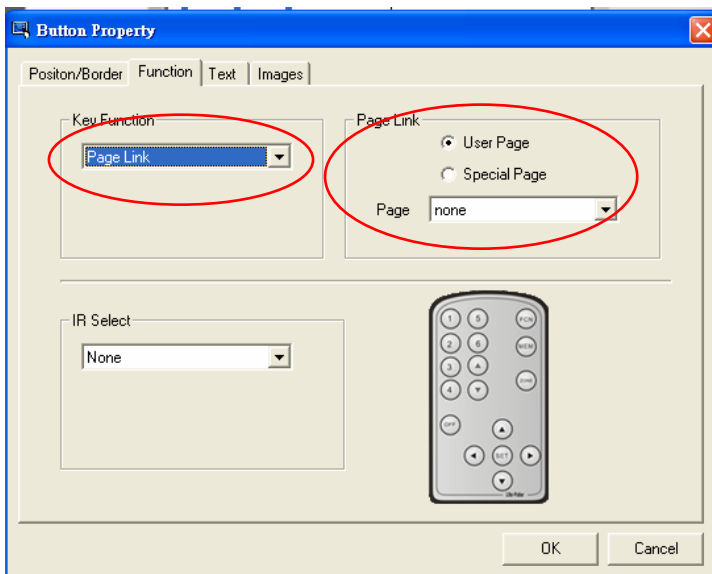

As the notion of User Page and Special Page on 2-4-2, user can select the pages that link to the buttons.

If select  User Page , user can select the pages from the list of Page Link column

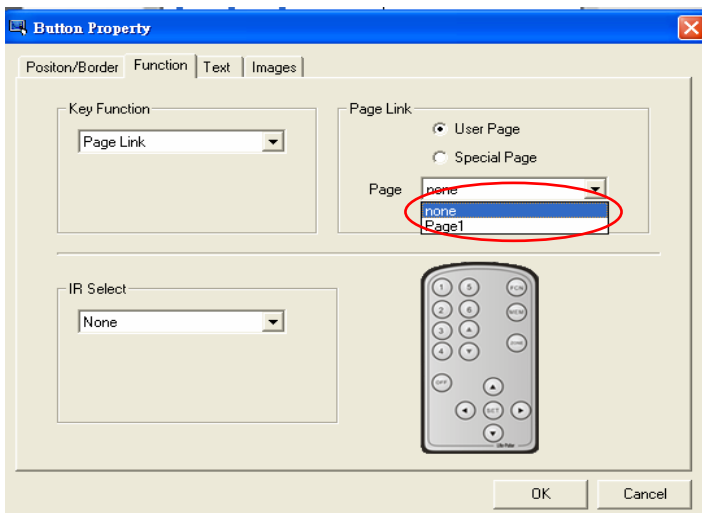

If select  Special Page , user can select the built- in function pages from the list of Page Link column.

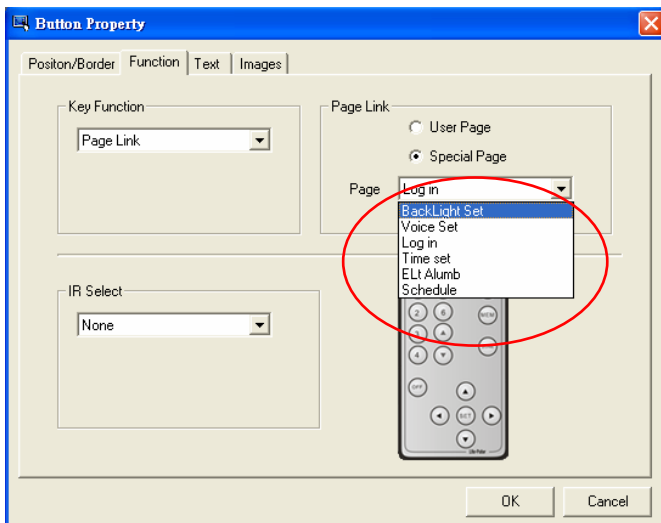

c. **SCENE**—if press the button, it will recall/turn off the corresponding scene  
 Select scene from key function list, it will display as below,

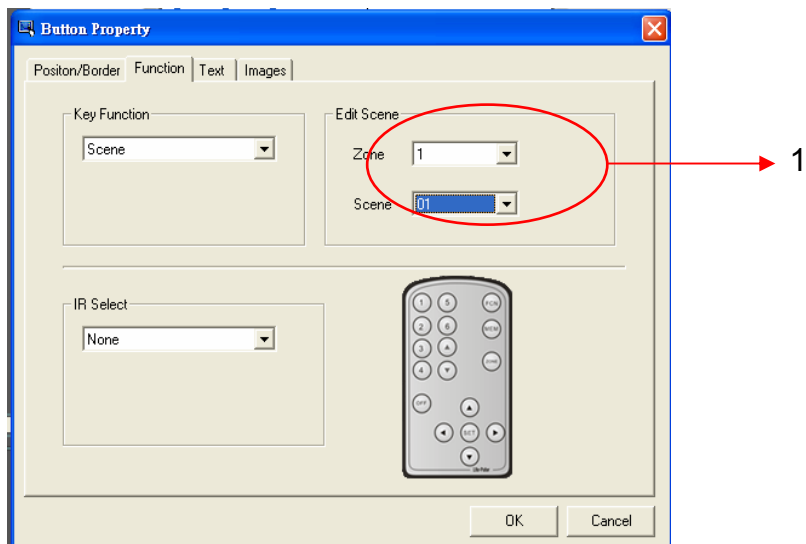

1---the scene's zone and status (ON/OFF) selection. The zone can be selected from 0-255 and scene from SC 1~SC 12 and SC OFF.

d. **Up/Down**—if press the button, it will increase/decrease the corresponding channel's dimming value.

Select Up/Down from key function list, it will display as below,

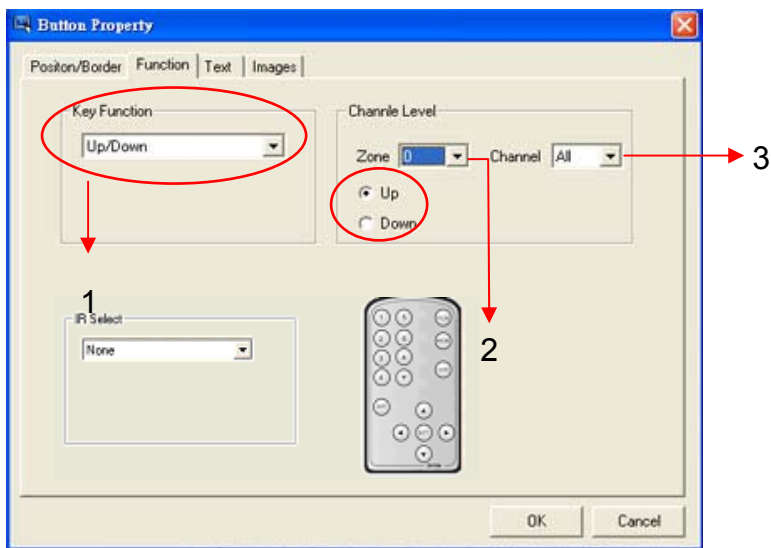

- 1---use  Up  Down to set the button to increase/ decrease the channel's dimming value.
- 2---channel's zone selection. (from 0~255)
- 3---channel selection. It can be any channel from 1~256 channel and all the 256channels)

e. **Dimmer**—if press the button, the channel will be turn on at preset dimming value; if release the button , the channel will be turn off.

Select Dimmer from key Function list, it will display as below,

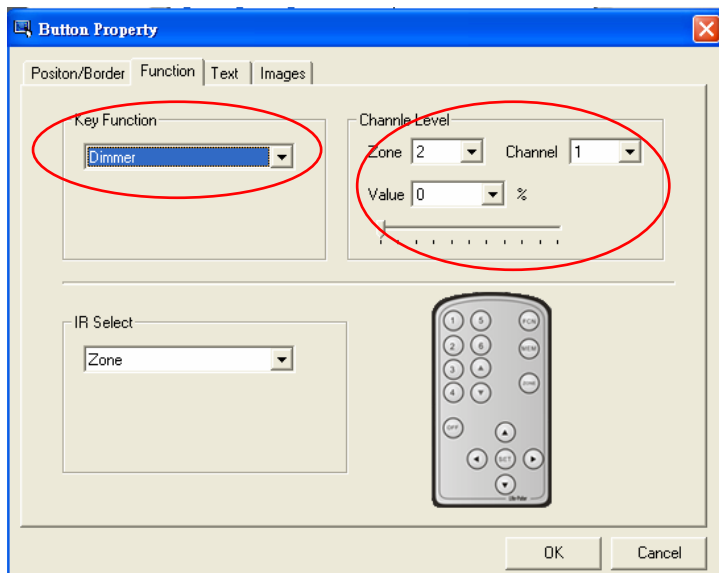

Set the Zone, Channel and Dimming Value on Channel Level column .

f. **Scene Save**—if press button, a scene can be saved.

Select Scene Save from Key Function list, it displays as below,

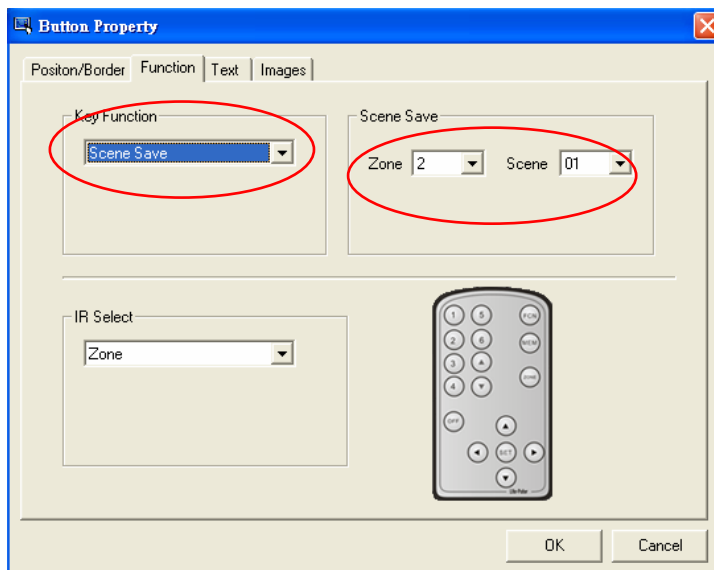

Select zone no. and scene no. on Scene Save column .The zone can be selected from 0-255 and scene from SC 1~SC 12 .

**h.Data Read**——if press the button, it will read the channel’s dimming value from the controller.

(Notice:ECP-T03 can’t display the channels’ current dimming value of the controller at real time, so it need the Data Read function to read them manually .)

## 2-6 Scene Operation

Notice: We do the scene editing and saving directly on this touch panel, but we do the component setting on the programming software and then download to this touch panel.(please refer to 2-2-1 Menu Introduction to check the download method.)

The following pages are example of user page.

**STEP-1** One of the user page displays as below,

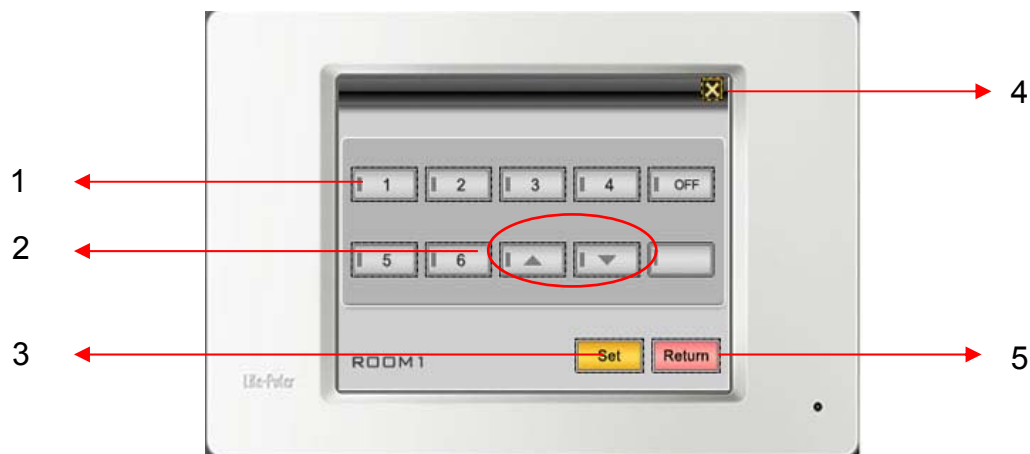

- 1----- 1~6 and OFF, the key function of these button set as Scene.
- 2----- These two button's key function set as Up/Down
- 3----- This button's key function set as Page Link. (it links to the user page as STEP-3 )
- 4----- This button 's key function set as Page Link.

**STEP-2** Press any button from SC1~6. and OFF(press SC1 as a example),it will display as below,



**STEP-3** Press Set links to the user page as below,

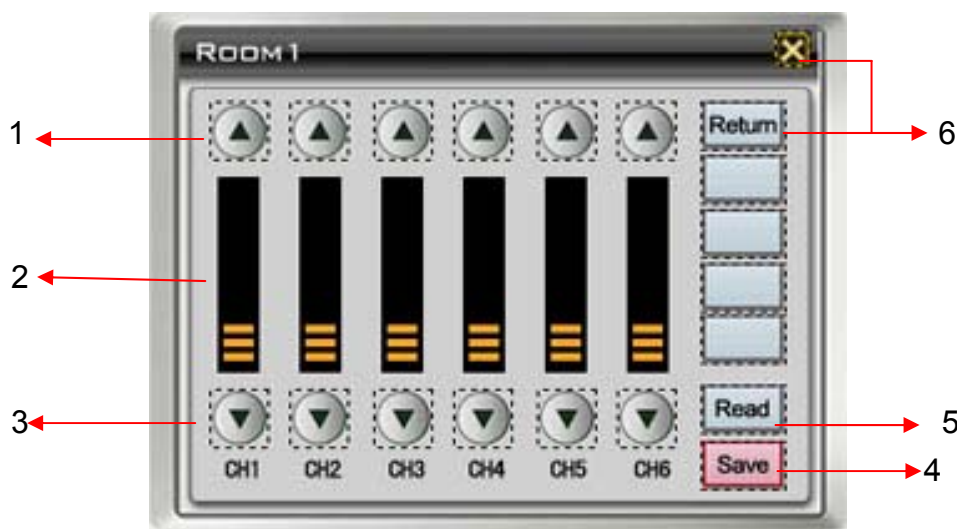



- 1,3----- These two Button 's Key function set as Up/Down
- 2----- channel's dimming value display bar.
- 4----- This button 's Key function set as Page Link.(it links to the user page as STEP-5 )
- 5----- This button 's Key function set as Data Read.

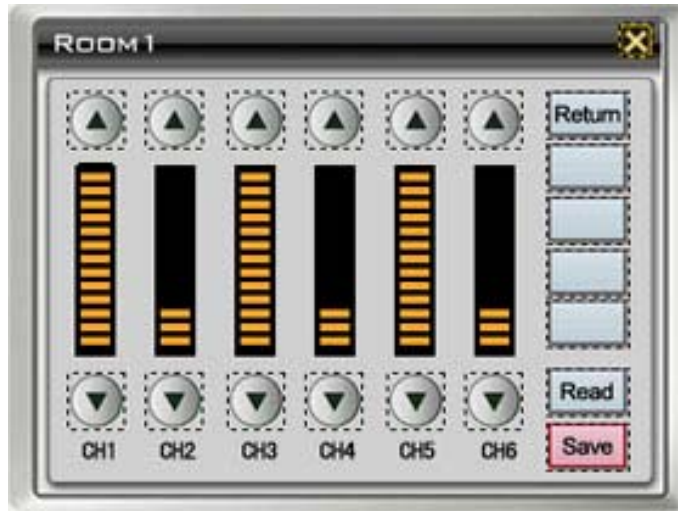

6----- This button 's Key function set as Page Link.

STEP-4 Press  of CH1,CH3,CH5to increase the dimming vaule to 100% and it displays as below,



STEP-5 Press  to save the scene and it will display as below,

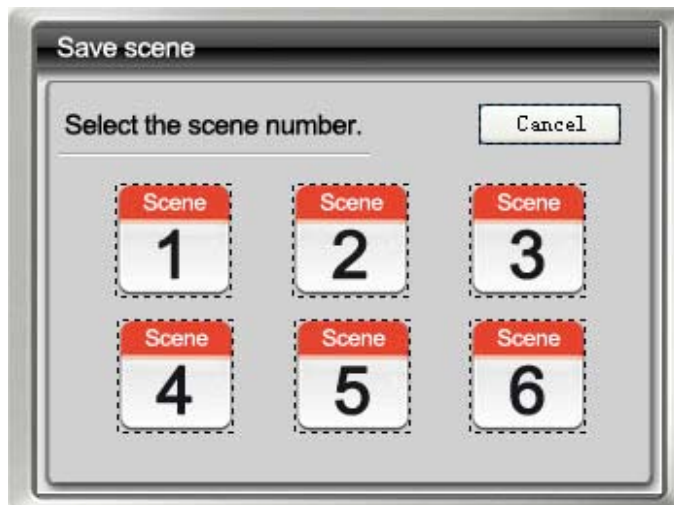

STEP-6 Press  and it will display as below,

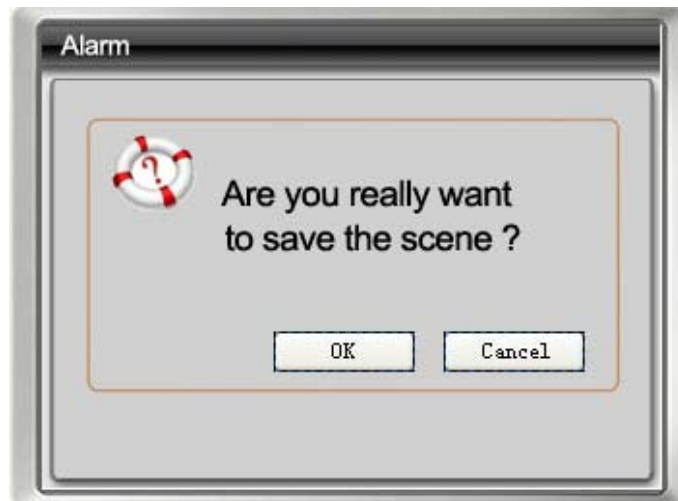

**STEP-7** Press OK to save the setting.

Notice: after save the scene, press SC1~6 and OFF on the below page to recall the corresponding scene.

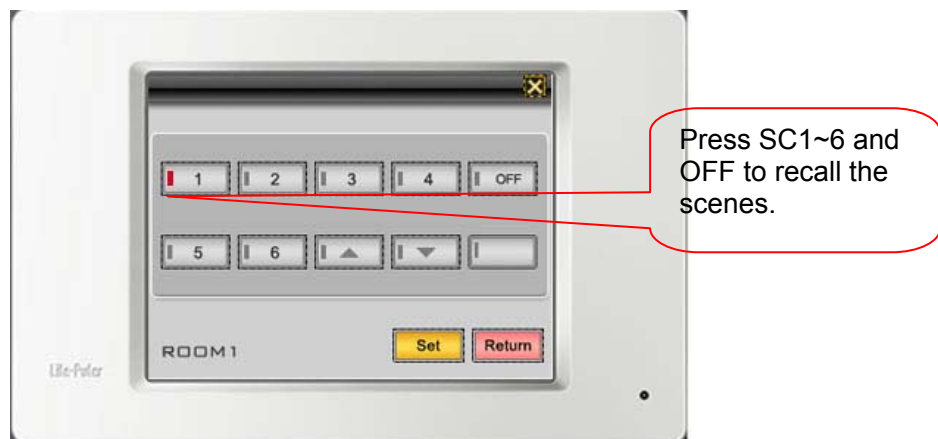

## 2-7 Schedule Setting

The Schedule setting is for recall the scenes at certain time.

**STEP-1** Open the programming software.

**STEP-2** From File menu—New project to the New Page.

**STEP-3** Press Button/Picture key on the interface or use the Component(c) menu to add a Button/Picture.

**STEP-4** Double click button and select the function property from the button property dialogue box. It will display as below,

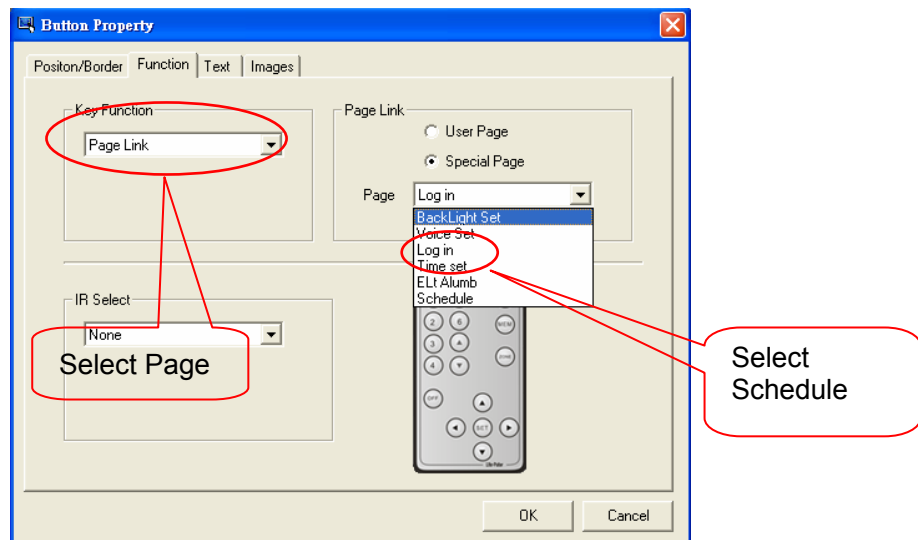

The setting of Text, Images, and Position/Border property, please refer to the steps of 2-3-1. For example, we set a Button as below,

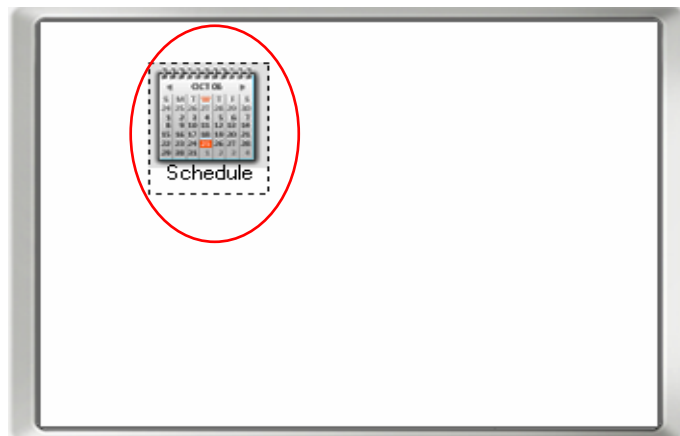

**STEP-5** Download this page to ECP-T03 and press this button, it will link to the build-in function page and displays as below,

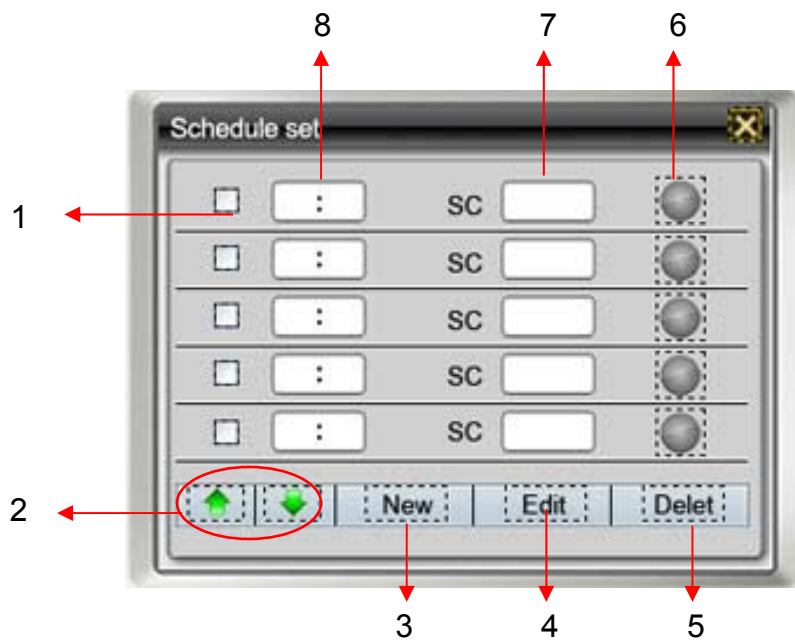

- 1-----whether to execute this schedule? (Yes: , No: )
- 2-----go to last or next schedule set page (ECP-T03 has 50 schedules; each page has 5 schedules, 10 pages in total.)
- 3-----add schedule
- 4-----edit schedule
- 5-----cancel schedule
- 6-----select schedule (the schedule can be edited and canceled, only after be selected; if the schedule's select, it will display as )
- 7-----the scene executed on the schedule
- 8-----the execution time for the schedule: hour and minute

For example,

STEP-6 Press  and it displays as below,



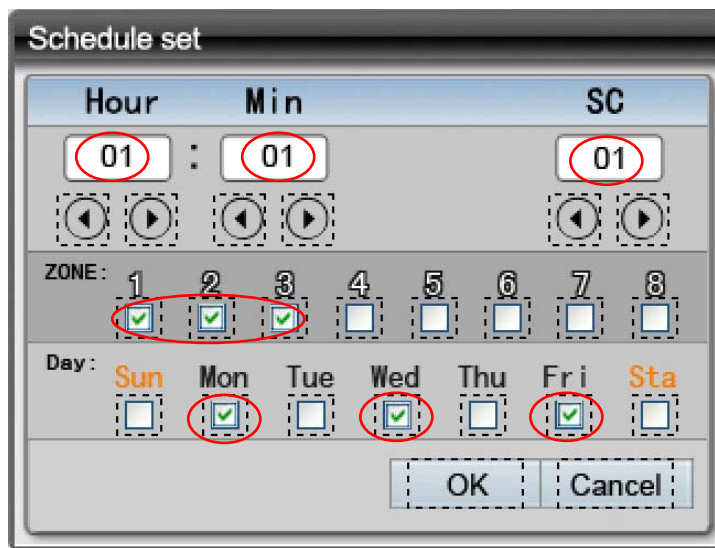

- 1-----the execution time for the schedule: hour and minute
- 2-----the adjustment keys for hour and minute setting of the execution time
- 3-----zone no. of the scene executed on the schedule (it can recall the first scenes of Zone 1 to Zone 8 at same time)
- 4----- the execution time for the schedule: date
- 5----- the adjustment keys for scene setting
- 6-----the scene executed on the schedule

STEP-8 If the schedule is that 01:01 am on every Monday, Wednesday and Friday, it will recall the SC01 of Zone 1, Zone 2 and Zone 3, it will display as below,

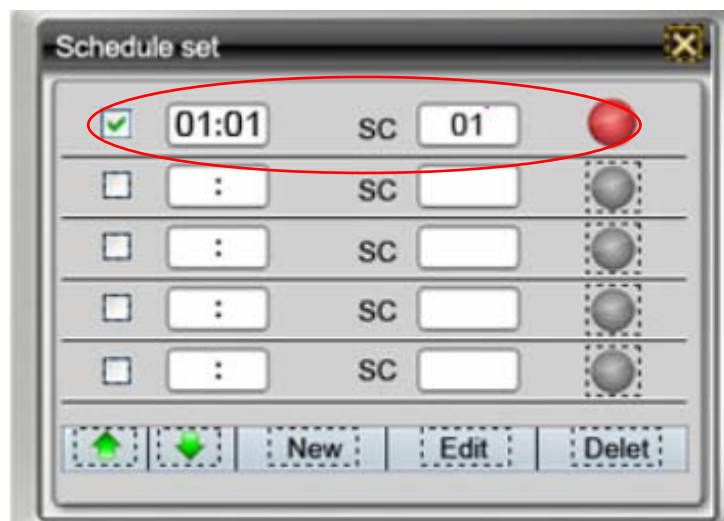

STEP-9 After setting, press OK to save and it will display as below,



It means the setting is saved and can be edited and canceled.  means the schedule is selected.

STEP-10 Press  to exit.

## 2-8 Component Configuration

Open the programming software, and add 3 components (for example, 3 buttons in different size on the page. It will display as below,

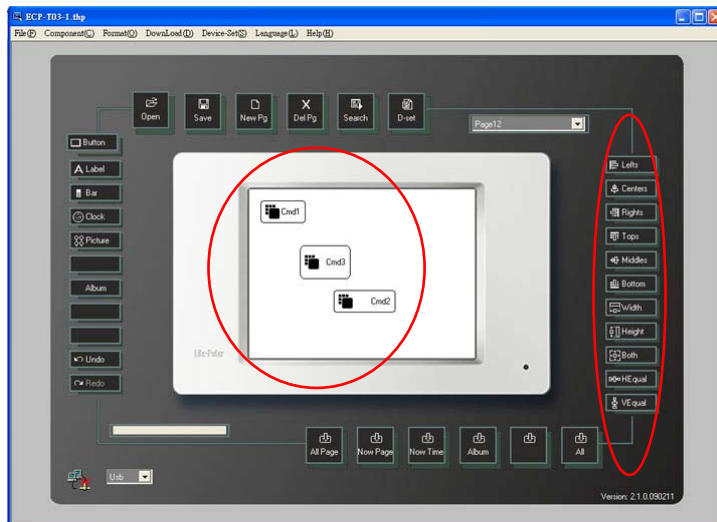

Left and right alignment:

Hold CTRL and select component Cmd1, Cmd2 and Cmd3, then press



to make those components align with left or right. It will display as below,

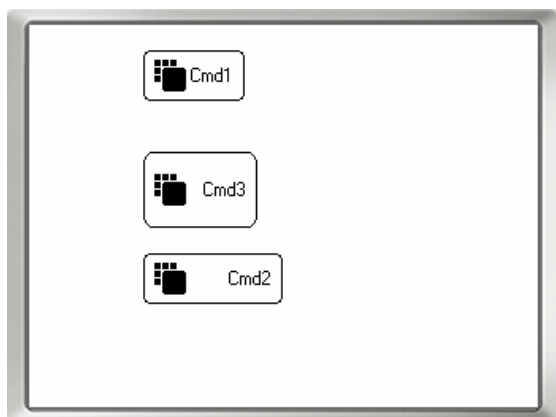

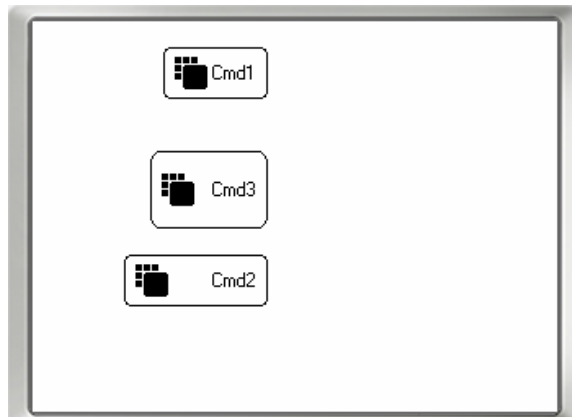

Align with left



Align with right

Center and middle alignment :

Hold CTRL and select component Cmd1, Cmd2 and Cmd3, then  or  to make those components align with center or middle. It will display as below,

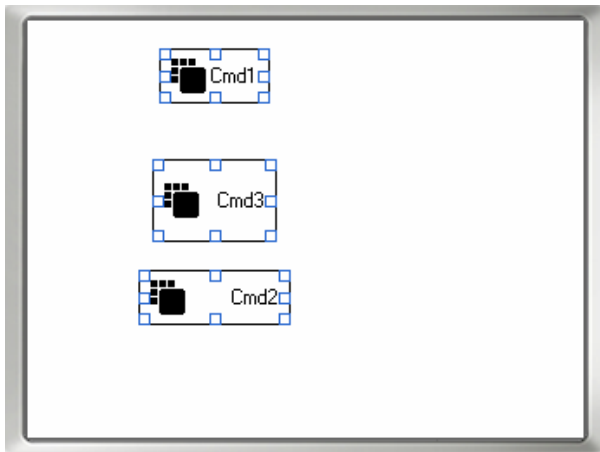

Align with center

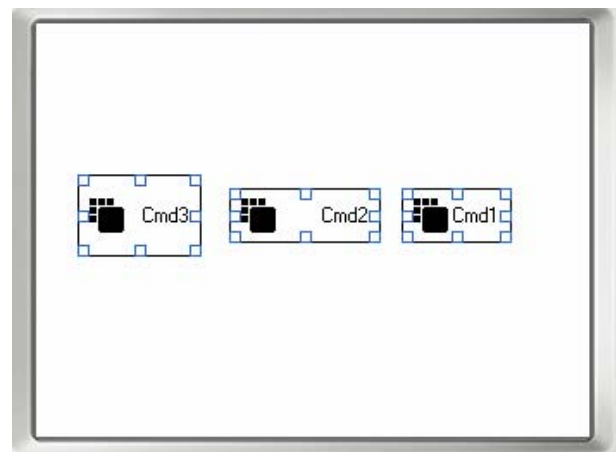

Align with middle

Top and bottom alignment:

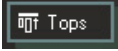
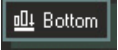
Hold CTRL and select component Cmd1, Cmd2 and Cmd3, then press  or  to make those components align with top or bottom. It will display as below,

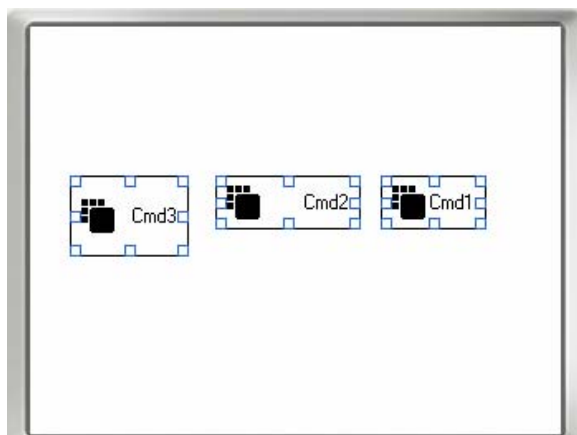

Align with top

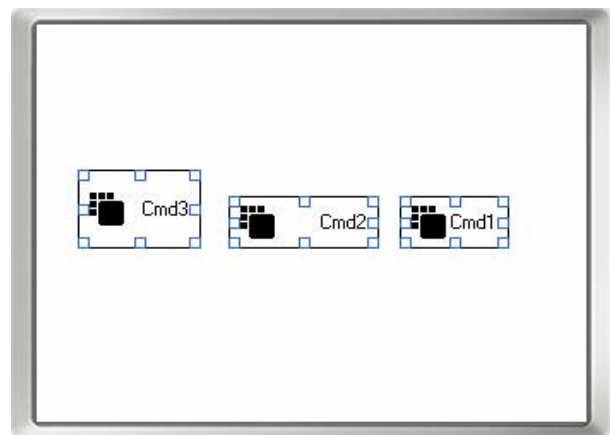

Align with bottom

Width and height

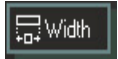
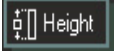
Hold CTRL and select component Cmd1, Cmd2 and Cmd3, then press  or  to make those components have same width and height. It will display as below,

Notice: If you want to make several components have same width and height, you need select the width and height of one as the standard. The component which was selected at the last time is the standard in our software.

For example: in the graphs below, we select Cmd1 as the standard.

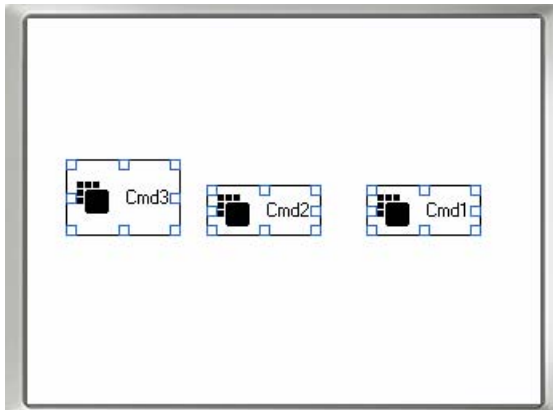

Make same width

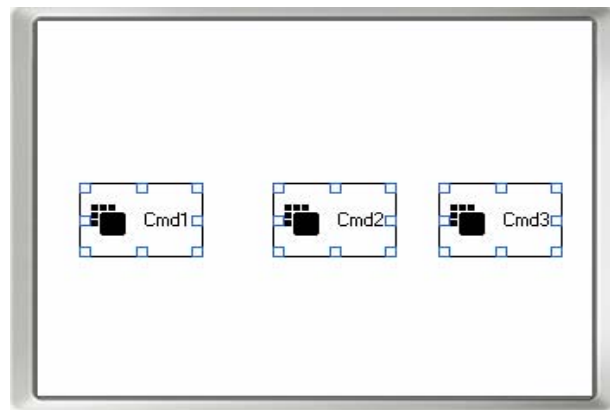

Make same width

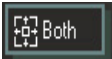
Press  to make Cmd1, Cmd2 and Cmd3 has the same width and height. The component which was selected at the last time is the standard in our software.

Horizontal Spacing Equal and Vertical Spacing Equal

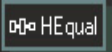
 Horizontal Spacing Equal

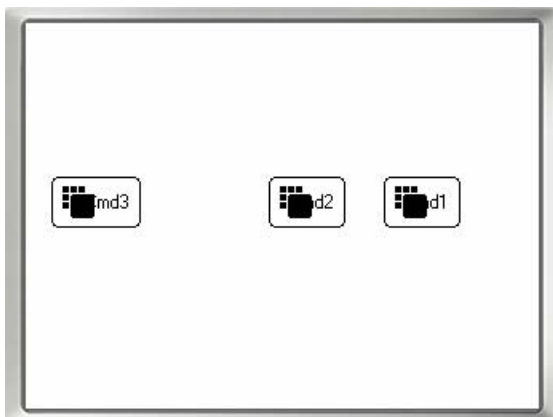

to

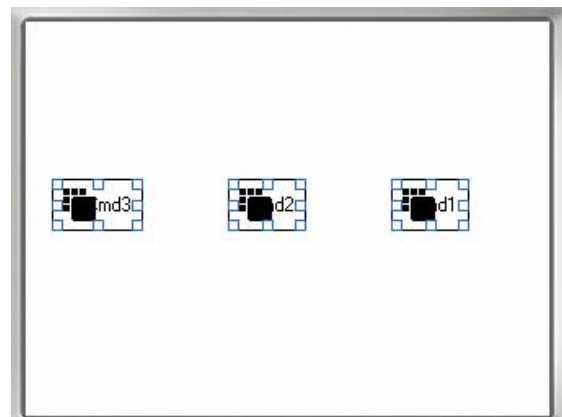

 Vertical Spacing Equal

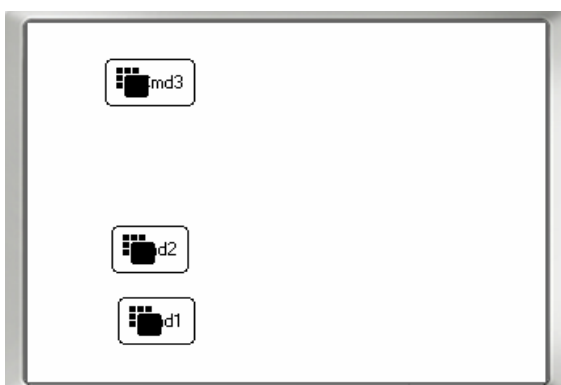

to

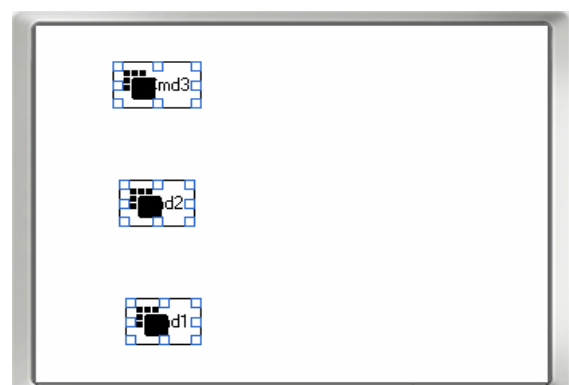







## 2-9 File Download

After the operation on the programming software, you must download the file to the ECP-T03 .

### Button on interface introduction

	Download all page data to device		Download system time to device
	Download current page data to device		Download all data to device
	Download album photo to device		

When the ECP-T03 connect with programming software , press the above buttons and it will display as below,



Download in progress



Download is ok

### Notice:



1.Press  to search device's IP. (only after connecting with ECP-T03)

**STEP-1** Open the programming software.



STEP-2 Press  and it will display as below,



STEP-3 Press search and it will displays below,:

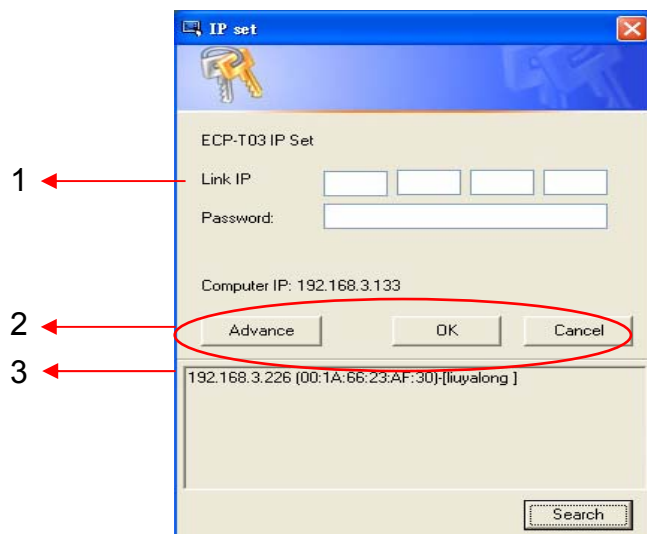

1-----IP address display column

2-----  column decides whether the device Information column display or not.

display ;  not display.

3-----device information column

STEP-4 Double click the device information column `192.168.3.226 (00:1A:66:23:AF:30)-[liuyalong ]`, and it will display as below,

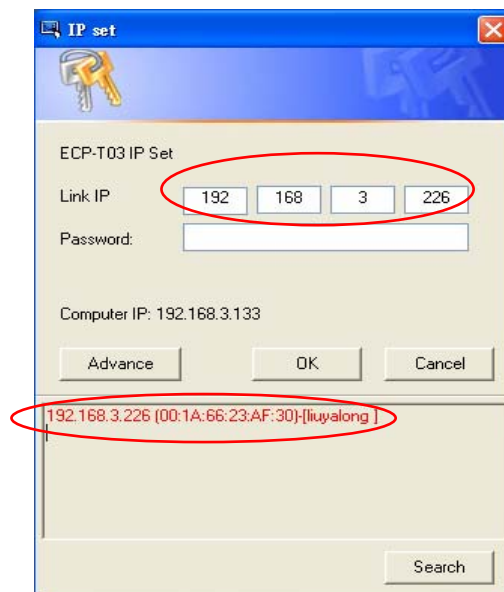

STEP-5 Press OK to finish the connection between ECP-T03 and programming software.



2. **D-set** Device setting

STEP-1 Open the programming software,

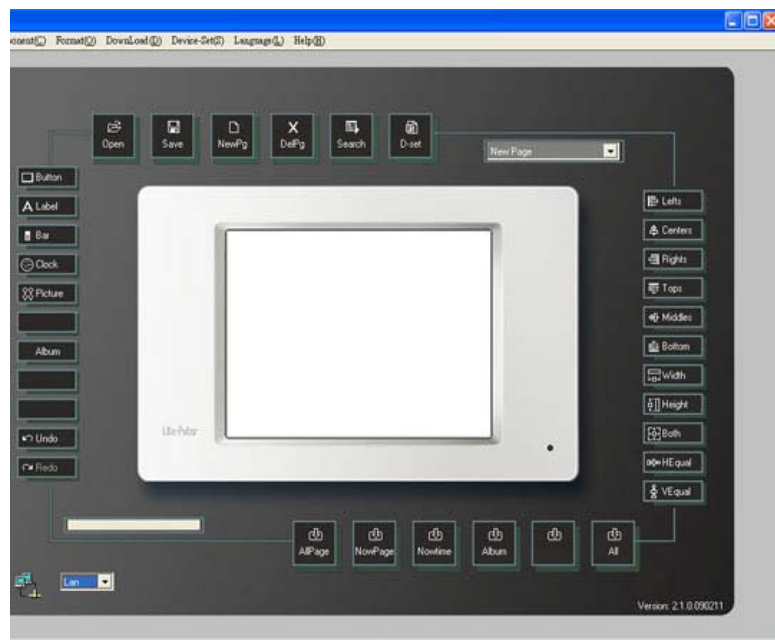

STEP-2 Press  and it will display as below,

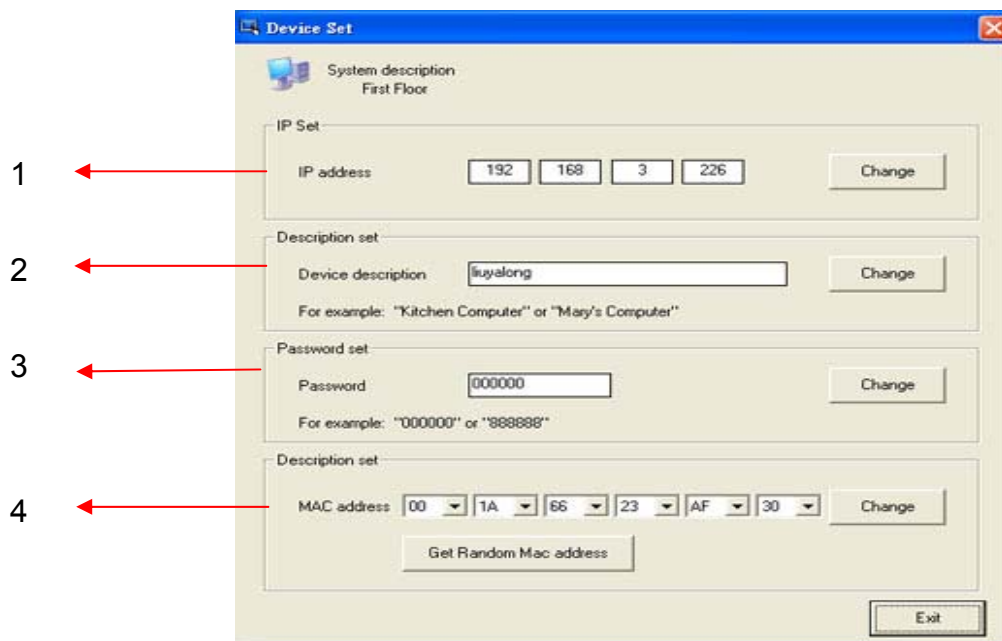

- 1-----IP address setting
- 2-----Device name setting
- 3-----Password setting
- 4---- MAC address setting

## Guarantee

Lite-Puter promises to fulfill the following acceptances:

1. Lite-Puter is only responsible for ECP-T03 itself.
2. Lite-Puter guarantees to keep Lite-Puter's fault products caused by techniques, materials and any other logical reasons in good repair for free within a year since the distributing date.
3. We do not offer door-visiting service. If the trouble appears in Lite-Puter's products, please deliver the equipment to local distributors or Taipei headquarter.

### \*\*\* Special Statement\*\*\*

Any fault caused by false usage, imprudence (collision or inadequate installation) or force majeure factors are not in Lite-Puter's service.

#### Revision Record

Version	Record
A	First version
B	Add photos to 1-4 Dimension

Issued on: June, 2009

## Lite-Puter

### **World Headquarter:**

Lite-Puter Enterprise Co., Ltd.

Address: 9F, No. 196, Sec. 3, Da Tung Rd., Shijr City, Taipei, Taiwan

Zip Code: 22103

Tel: +886-2-86472828

Fax: +886-2-86472727

Website: [www.liteputer.com.tw](http://www.liteputer.com.tw)

E-mail: [sales@liteputer.com.tw](mailto:sales@liteputer.com.tw)

### **Shanghai Factory:**

Lite-Puter Technology (Shanghai) Co., Ltd.

Address: Building B5, No. 298, Lane 3509, Hongmei S. Road, Shanghai, China

Zip Code: 201108

Tel: +86-21-54408210

Fax: +86-21-64978079

### **Shanghai Sales Center:**

Address: Room 701, Building Gem, No. 487, Tianlin Road, Shanghai, China

Zip Code: 201103

Tel: +86-21-33674316/33674850

Fax: +86-21-33674013

Website: [www.liteputer.com.cn](http://www.liteputer.com.cn)

E-mail: [sales\\_china@liteputer.com.tw](mailto:sales_china@liteputer.com.tw)